

Chillers and Inverter Air/Water heat pumps with axial fans

Technical Bulletin

Models

i-290 0106
i-290 0109
i-290 0112
i-290 0115
i-290 0118



This manual has been created for informative purpose. The company declines any responsibility for the results of any projecting or any installation based on the explanations and/or on the technical specifications provided in this manual. It is besides forbidden the reproduction under any form of the texts of the figures contained in this manual. This manual is a translation from the official italian language version. For reasons of environmental respect the Company will not provide the hard copy in the original language which could be directly requested or downloaded from the Company website at any time. In case of any dispute, the original language manual will be the trusted one. Even partial reproduction PROHIBITED © Copyright - Advantix SpA

01	03-2024	EG	AR	Added minimum load data, various corrections
00	03-2023	EG	AR	First issue
Rev	Date	Author	Supervisor	Notes
Catalogo / Catalogue / Katalog / Catalogue				Serie / Series / Serie / Serie / Série
BTE02050120001_01				INVERTER AIR/WATER HEAT PUMPS WITH AXIAL FANS

Contents

1. DESCRIPTION OF UNIT AND TECHNICAL SPECIFICATIONS	6
1.1 FRAMEWORK	6
1.2 COMPRESSORS	6
1.3 AIR SIDE HEAT EXCHANGER	6
1.4 UTILITY SIDE HEAT EXCHANGER	6
1.5 EC FAN	6
1.6 COOLING CIRCUIT	6
1.7 ELECTRICAL PANEL	8
1.8 CONTROL SYSTEM	8
1.9 CONTROL AND PROTECTIVE DEVICES	8
1.10 WATER CIRCUIT	8
2. DESCRIPTION OF VERSIONS AND ACCESSORIES	8
2.1 VERSIONS	8
2.2 LIST OF ACCESSORIES	9
2.3 DESCRIPTION OF ACCESSORIES	10
2.3.1 Component supplied as standard	10
2.3.2 Factory-fitted accessories	11
2.3.3 Accessories supplied separately	11
2.4 SAFETY RULES FOR R290 UNITS TRANSPORT AND STORAGE	13
3. INSTALLATION	13
3.1 GENERAL	13
3.2 TRANSPORT AND STORAGE TEMPERATURE LIMITS	15
3.3 UNIT DIMENSIONS, PLUMBING CONNECTIONS AND WEIGHTS	15
3.3.1 Net dimensions and with packaging	15
3.3.2 Models i-290 0106 / 0109	15
3.3.3 Models i-290 0112 / 0115 / 0118	16
3.3.4 Weights	16
3.4 POSITIONING AND MINIMUM TECHNICAL CLEARANCES	16
3.5 DANGER AND SAFETY ZONES	18
3.5.1 Free-field ground installation	19
3.5.2 Ground installation in front of a wall	19
3.5.3 Ground installation in a corner	20
3.5.4 Flat roof installation	20
3.5.5 Multiple installation	21
3.6 PLUMBING CONNECTIONS	21
3.6.1 Characteristics of the circuit water	21
3.6.2 Typical plumbing diagram	22
3.6.3 Minimum water content and hydraulic circuit volumes	23
3.6.4 Plumbing diagram inside unit	23
3.6.5 Condensation drain system	24
3.6.6 System load	25
3.6.7 System discharge	25
4. GENERAL TECHNICAL DATA	26
4.1 STANDARD UNIT DATA TABLE	26

4.2	ELECTRICAL AND AUXILIARY DATA.....	28
5.	CORRECTION FACTORS.....	29
5.1	CORRECTION FACTORS FOR USE OF GLYCOL WATER MIXTURE.....	29
5.2	SCALING CORRECTION FACTORS.....	29
5.3	INSTRUMENTATION CALIBRATIONS AND PROTECTIONS.....	29
5.4	CORRECTION FACTORS ACCORDING TO ALTITUDE	29
6.	HYDRONIC UNIT DATA.....	30
6.1	USEFUL HEADS.....	30
6.2	CHARACTERISTIC CURVES OF CIRCULATORS	30
7.	SOUND EMISSIONS ACCORDING TO EN 12102-1:2022	31
7.1	FULL LOAD UNITS	31
7.2	PARTIAL LOAD UNITS.....	32
8.	OPERATING LIMITS	32
8.1	EVAPORATOR WATER FLOW	32
8.2	COLD WATER PRODUCTION (SUMMER MODE)	33
8.3	HOT WATER PRODUCTION (WINTER MODE).....	33
8.4	AMBIENT AIR TEMPERATURE AND SUMMARY TABLE	33
8.5	ENVELOPE IN HEATING AND COOLING.....	34
8.6	ENVELOPE IN DHW	35
9.	PERFORMANCE TABLES.....	36
9.1	HEATING	36
9.2	COOLING	38
9.3	SANITARY.....	39
9.4	MINIMUM LOAD.....	39
10.	SEASONAL PERFORMANCE AT DIFFERENT TEMPERATURE LEVELS	41
11.	DATA FOR THE ENERGY CERTIFICATION OF BUILDINGS ACCORDING TO UNI/TS 11300-4 FOR HEAT PUMPS	42
11.1	EER DATA TO CALCULATE THE ENERGY PERFORMANCE OF BUILDINGS, ACCORD- ING TO UNI/TS 11300-3	45
12.	REFRIGERANT SAFETY DATA SHEET	48

1. DESCRIPTION OF UNIT AND TECHNICAL SPECIFICATIONS

The i-290 heat pumps were designed for residential and commercial applications. They are extremely versatile and prepared for heat pump operation with hot water production for ambient heating and for sanitary use at a temperature of 75°C. The refrigerant employed is R290 gas, which, thanks to its low GWP, ensures a long term solution in terms of efficiency and environmental sustainability. Use of the INVERTER-controlled brushless compressor technology, coupled with electronic expansion valve, circulator pump and variable speed fan ensures excellent performance, due to the optimisation of the specific consumption and the high modulating capacity, which in turn translate into high COP and EER values.

1.1 FRAMEWORK

All units of the range are manufactured from continuously hot-dip galvanised sheet steel and painted with polyurethane powders in an oven at 180°C to ensure the best weather resistance.

The sheets are painted with a corrosion resistance class of C3-M, according to ISO 12944-2.

The frame is self-supporting with removable panels for easier inspection and maintenance of the inner components. All screws and rivets for outdoor installation are in galvanised steel.

The front grids of the units are also tested according to EN ISO 4892-2 to be resistant to the accelerated ageing phenomena of plastics produced by solar radiation and weathering.

1.2 COMPRESSORS

Twin rotary hermetic inverter controlled DC compressors, are designed to operate with R290, equipped with thermal protection and mounted on rubber vibration dampers.

The compressors are installed in a compartment separated from the air flow to reduce noise. They are also equipped with crankcase heater to prevent oil dilution and consequently galling.

The compressors can be inspected by removing the side and front panels of the unit, so that they can be serviced even with the units running.

1.3 AIR SIDE HEAT EXCHANGER

The air heat exchangers are made of copper pipes and prepainted aluminium fins. The pipes are mechanically expanded into aluminium fins to increase the thermal exchange factor. The shape of these exchangers allows a low air side pressure drops and therefore fans can run at low speed (thus reducing unit noise). As optional the coils can be supplied with a "SILVER LINE" to allow greater resistance to acidity and salt spray resulting in increased hydrophilic ability and performance compared to a battery with simple aluminium fins. The air side exchangers are designed to minimise the refrigerant gas charge.

1.4 UTILITY SIDE HEAT EXCHANGER

The utility heat exchangers are the brazed plate type, made of stainless steel AISI 304, insulated at the factory with closed cell material. They can be equipped with anti-freeze electric heater (optional KA accessory). Each evaporator is protected by a temperature sensor used as an antifreeze protective probe which activates the circulator, even when the machine is switched off, if the conditions imposed on the control occur.

1.5 EC FAN

The fans are made of plastic, the axial type with airfoil blades. They are all statically and dynamically balanced and are supplied complete with protective grid. All electric motors used are brushless modulating to optimise the evaporation/condensation pressure in summer/winter operation so as to allow the correct operation of the machine. The motors are directly coupled and equipped with integrated thermal protection with IP54 rating.

1.6 COOLING CIRCUIT

The cooling circuit is made with components of leading international companies and in compliance with UNI EN standard 13134 on brazing procedures. The coolant is the new R290 (GWP equal to 0,02) ecological gas. The basic version of the cooling circuit includes: 4-way cycle reversing valve, electronic expansion valve, liquid separator integrated with the compressor, liquid receiver (only for i-290 0112, 0115, and 0118 units), safety device (high-pressure switch), pressure transducers to carefully measure evaporation and condensing pressure, bidirectional metal mesh filters to avoid obstructions on the lamination valve. The suction pipe is thermally insulated thanks to a closed cell elastometric foam.

A pressure test is performed to detect any potential leakage and the unit is supplied already charged with the optimal amount of gas for proper functioning.

Circuit diagram i-290 0106, 0109

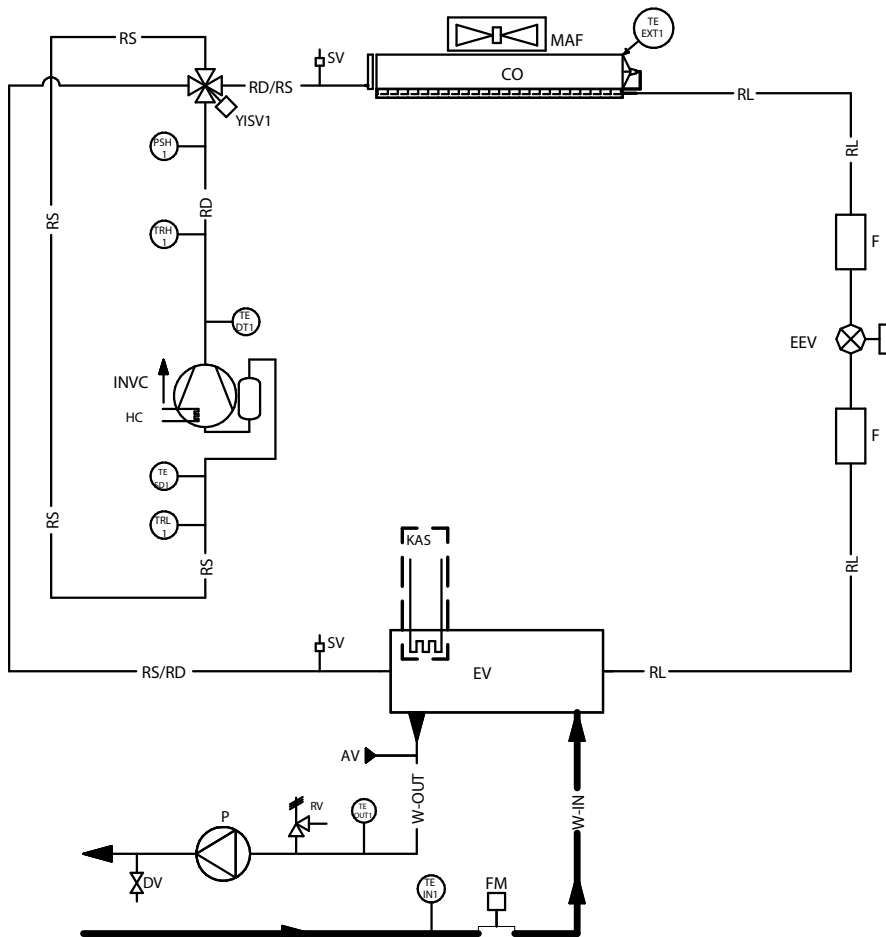

Circuit diagram i-290 0112, 0115, 0118

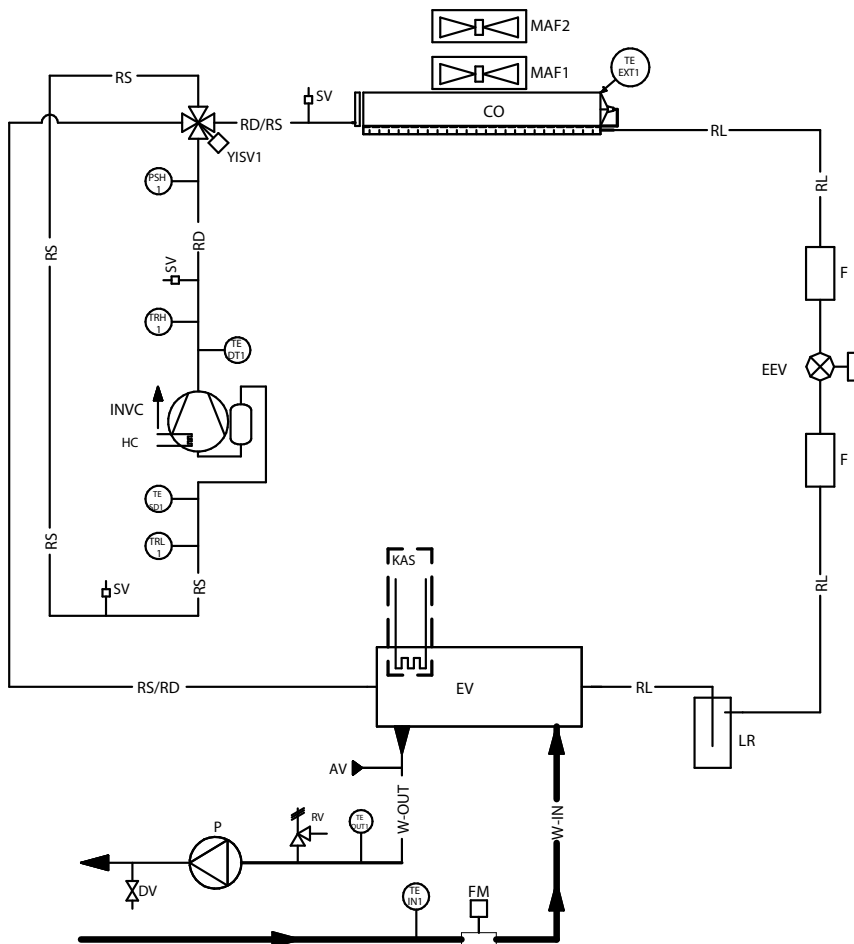

ACRONYM	DESCRIPTION	ACRONYM	DESCRIPTION
INVC	VARIABLE SPEED COMPRESSOR	RD	DISCHARGE LINE
CO	COIL	RL	LIQUID LINE
EV	PLATE HEAT EXCHANGER	RD/RS	DISCHARGE/SUCTION LINE
EEV	ELECTRONIC EXPANSION VALVE	RS/RD	SUCTION/DISCHARGE LINE
YISV	4-WAY CYCLE REVERSING VALVE	W-OUT	SYSTEM WATER OUTLET LINE
LR	LIQUID RECEIVER	W-IN	SYSTEM WATER INLET LINE
F	FILTER	TRH	HIGH PRESSURE TRANSDUCER
SV	FILLING CONNECTION	TRL	LOW PRESSURE TRANSDUCER
HC	CRANKCASE HEATER	TE EXT	OUTDOOR AIR TEMPERATURE PROBE
MAF	AXIAL FAN	TE SD	INTAKE LINE TEMPERATURE PROBE
RS	SUCTION LINE	TE DT	COMPRESSOR DISCHARGE TEMPERATURE PROBE
KAS	PLATE EXCHANGER ANTIFREEZE HEATER	PSH	HIGH PRESSURE SWITCH

1.7 ELECTRICAL PANEL

The electric panel is designed in compliance with current European standards. The electric panel can be accessed by removing the cover on the unit using a specific tool. The electric panel has an IPX4 protection rating. The panel is also supplied with an auxiliary board for electrical connections and utilities. The auxiliary board has digital inputs with voltage-free contact for:

- Remote ON-OFF.
- Summer/winter mode.
- Double set-point control.

There are also analogue inputs for:

- Domestic hot water sensor.
- Storage sensor.

Below listed the digital inputs (max. voltage available for input: 0,5 A)

- Machine stall alarm.
- 3-way valve for Domestic Hot Water control.
- Double set-point control.

The system is pre-fitted with connectivity arrangement for ModBus RTU RS-485 monitoring and 12 VAC supply i-CR wall-mounted controller.

1.8 CONTROL SYSTEM

All i-290 units are equipped with microprocessor with overheating control logic by means of an electronic thermostatic valve managed according to the signals sent by the pressure transducers. The CPU also controls the following functions: water temperature control, antifreeze protection, compressor timing, alarm reset, alarm management and operating LEDs. The control system, with the INVERTER technology and on board sensors, monitors and continuously adapts the performance of the inverter compressor, of the circulator and of the fan (2 fans in models 0112, 0115 and 0118).

1.9 CONTROL AND PROTECTIVE DEVICES

All the units are standard supplied with the following control and protective devices: return water temperature sensor, installed on water return pipe from the system, working and antifreeze probe installed on the water discharge pipe to the system, high pressure transducer, low pressure transducer, temperature probes on both the compressor's suction and discharge lines, compressor thermal protection, fan thermal protection, water side flowmeter protecting the evaporator, high pressure switch.

1.10 WATER CIRCUIT

i-290 chillers are supplied with a built-in water circuit which includes: modulating circulator with high-efficiency brushless motor (EEI≤0,21), suitable for the use of chilled water and managed directly by the machine's controller, plate heat exchanger, flowmeter, safety valve (3 bar) bound to a discharge system and a deaerator supplied with air vent valve.

2. DESCRIPTION OF VERSIONS AND ACCESSORIES

2.1 VERSIONS

i-290 - reversible heat pump with built-in hydronic unit (safety valve, modulating circulator, flowmeter, filling/drain valve). Available models: 0106, 0109, 0112, 0115 and 0118. Sizes 0106, 0109, 0112 provide a single-phase power supply, while sizes 0115, 0118 require a three-phase power supply.

The unit code consists of the following elements:

- 7 fixed digits.
- the symbol # as separator.
- 8 variable digits (fields) identifying the sizes, power supply and factory mounted accessories.
- 2 variable digits (MC field) which identify the i-290 series in any customisations.

0112422#{VR}{AE}{CT1}{KA}{CR}{TR}{RP}{AC1}{MC}

Order code	0112422#	-
Unit version (VR)	2	Standard
Alimentazione elettrica (AE)	0	Single-phase
	1	Three-phase
Power supply (CT1)	35	0106 (*)
	36	0109 (*)
	37	0112 (*)
	38	0115 (**)
	39	0118 (**)
Antifreeze kit (KA)	0	Without antifreeze kit
	1	With antifreeze kit (KA)
	3	Base frame resistance (KA3)
Remote control (CR)	0	Modbus protocol
Coil treatment (TR)	0	None
	8	Coil with Silverline treatment (TR2)
	9	Coil and sheet metal treatment (TR2C4)
Protection grids (RP)	0	None
	1	Coil protection grids (RP)

(*) Variants not valid for AE=1

(**) Variants not valid for AE=0



CAUTION: The antifreeze kit is a factory mounted accessory. It is not possible to install it later.

2.2 LIST OF ACCESSORIES

The available accessories for the i-290 heat pumps are listed below.

	Accessory	Standard	Factory-fitted	Supplied separately
Vibration damper kit	x			x
K2 - Antifreeze kit (exchanger + base frame)	x		x	
K3 - Antifreeze kit (base frame only)	x		x	
TR2 - Coils anticorrosion treatment	x		x	
TR2C4 - Anti-corrosion treatment on coil and sheet metal	x		x	
Coils protection grids	x		x	
Condensate drip tray	x			x
Y-filter	x			x
Filling /drain valve		x	x	
Water side safety valve		x	x	
Bag kit (screws, cable clamp, connector)		x	x	
Screwdriver for user board terminals		x	x	
VDIS2 - Diverter valve Kvs 19.2	x			x
Electronic throttling valve		x	x	
Antifreeze thermal drain valve	x			x
SAS - Domestic hot water probe / System remote probe	x			x
SPS - Solar panel probe for GI3	x			x
Flowmeter (flow presence signal)		x	x	
Hi-T2 - Multifunctional touch screen remote control	x			x
e-LITE - Multifunctional touch screen remote control		x		x
GI3 - External system management module	x			x
FD - Dirt separator	x			x
Unit lifting belts	x			x
Deaerator		x		x
Electronic circulator		x	x	
Remote on/off voltage-free contact		x	x	
BMS connectivity arrangement - ModBus protocol included (CM)		x	x	

	Accessory	Standard	Factory-fitted	Supplied separately
USB/RS485 Serial Converter (ISK)	x			x
LAN/Wi-Fi Local Converter (LNC)	x			x
OpenVPN LAN/Wi-Fi 3G Remote Converter (OVPN)	x			x
Editing the dynamic set-point - climate curve (via external air probe fitted in the unit)		x		x
Voltage-free contact for Summer/Winter selection		x		x
Machine block signal		x	x	
Enabling maximum Hz (*)		x		x
Enabling minimum Hz (*)		x	x	
Digital input for double set-point *		x		x

(*) Functions can be enabled as an alternative.

2.3 DESCRIPTION OF ACCESSORIES

2.3.1 Component supplied as standard

Electronic circulator - standard on the unit, electronically controlled and high efficiency.

Flowmeter (flow presence signal) – this device monitors and signals water circulation in the plate heat exchanger. This component is essential because it switches off and secures the unit preventing the formation of ice.

Electronic throttling valve – expansion valve, designed for the control and continuous regulation of the amount of refrigerant entering the evaporator. To optimise consumption, changes in thermal load can be monitored quickly.

Water side safety valve - valve installed on the hydraulic circuit to control overpressure - setting 3 bar.

Filling / drain valve - there is always a service valve in the unit that is used to fill/discharge the amount of water in the system or adjust the glycol percentage.

Bag kit (screws, cable clamp, connector) – located inside the user card box. It contains the following components:

- N. 6 self-tapping screws, class C15.
- N. 3 cable clamps with screw fastening.
- N. 1 90° drain fitting with seal.

Screwdriver for user board terminals - useful screwdriver to facilitate the opening of the user board connection terminals.

Deaerator - component to continuously capture and expel air and any other gases dissolved in the water in the hydraulic circuit. The removal efficiency of this device is very high, allowing the elimination of non-condensable gases present in the circuits down to microbubble level.

Unit lifting belts - belts required for the correct handling of the unit.

e-LITE - Multifunctional touch screen remote control with capacitive LCD for wall-mounted installation in residential and commercial indoor environments for heat pump management. The device replicates all functions on board the unit.

Remote on/off voltage-free contact – contact on the auxiliary board which allows the unit to be switched on and off.

Changing the dynamic set-point - climatic curve (via external air probe in the unit) - the controller allows the set-point to be changed by adding a value depending on the temperature of the outside air probe.

Voltage-free contact for Summer/Winter selection – option of remotely controlling the heating or cooling mode of the heat pump.

Machine block signalling - control system signalling of locked unit (can be reset manually). Alternatively, one of the following functions can be activated (contact after-sales service):

- Alarm signalling;
- Defrosting signalling;
- Compressor running signalling;
- Season signalling;
- System integration resistor management;
- Sanitary integration resistor management;

Enabling minimum Hz - With the activation of this function (which must be done following the procedure described in the control manual) the unit will reduce the power consumption by approximately 10% of the nominal reference value, resulting in a reduction in capacity. Alternative function at maximum Hz.

Enabling maximum Hz - With the activation of this function (which must be enabled by the after-sales service) the unit will increase the capacity by approximately 10% over the reference nominal value, resulting in an increase in power consumption. Alternative function at minimum Hz.

Digital input for double set-point - input to change the set point.

BMS connectivity arrangement - ModBus protocol included (CM) - accessory to connect the unit to external controllers via serial cable with RS-485 electric standard and ModBus RTU protocol.

2.3.2 Factory-fitted accessories

KA - Antifreeze kit (exchanger + base frame) - It involves the use of a self-heating cable that is fixed to the base of the unit in the vicinity of the condensation coil and a PET resistance placed on the face of the plate heat exchanger.

KA3 - Antifreeze kit (base frame only) - This only involves the use of a self-heating cable that is applied to the base of the unit near the condensation coil.

TR2 - Coil anticorrosion treatment - With the treatment the coil becomes flexible to withstand contractions and thermal expansions, it is mechanically resistant, UV-protected and dirt repellent. Heat transmission losses are very low. The treatment ensures coil protection in all environmental conditions: from marine to rural settings, from industrial to urban areas.

For specific cleaning instructions for coils treated in this way, please refer to the chapter in the user-installer manual 'Cleaning of Corrosion Treated Coils'.

The treatment withstands 6000 h according to ASTM B117.

TR2C4 - Anti-corrosion treatment on coil and sheets - provides for a TR2 type treatment of the coil (as described above) and, in addition, the hot-dip galvanised steel panels are painted to conform to machine installations in C4H environments, according to UNI EN 12944. The external screws are in AISI304 class A2 material.

The fan protection grid is also included in the treatment, while the galvanised sheets inside the machine (frame case and inductances) are excluded.

Coil protection grids - wire mesh to prevent the intrusion of foreign bodies inside the battery and to protect the battery from accidental contact with things or people (can also be ordered as a separate accessory).

2.3.3 Accessories supplied separately

Vibration damper kit – they prevent transmitting vibrations to the structure; they must be fitted into the appropriate holes underneath the unit.

G13 - External plant management module - allows management of the following functions:

- Recirculation circulator management.
- System-side mixing valve management.
- Solar thermal integration management.

VDIS2 - Diverter valve VDIS2 - DN motorised 3-way ball valve (1"1/4) Kvs 19,2, connections MMM 1" ½ complete with servo-control.

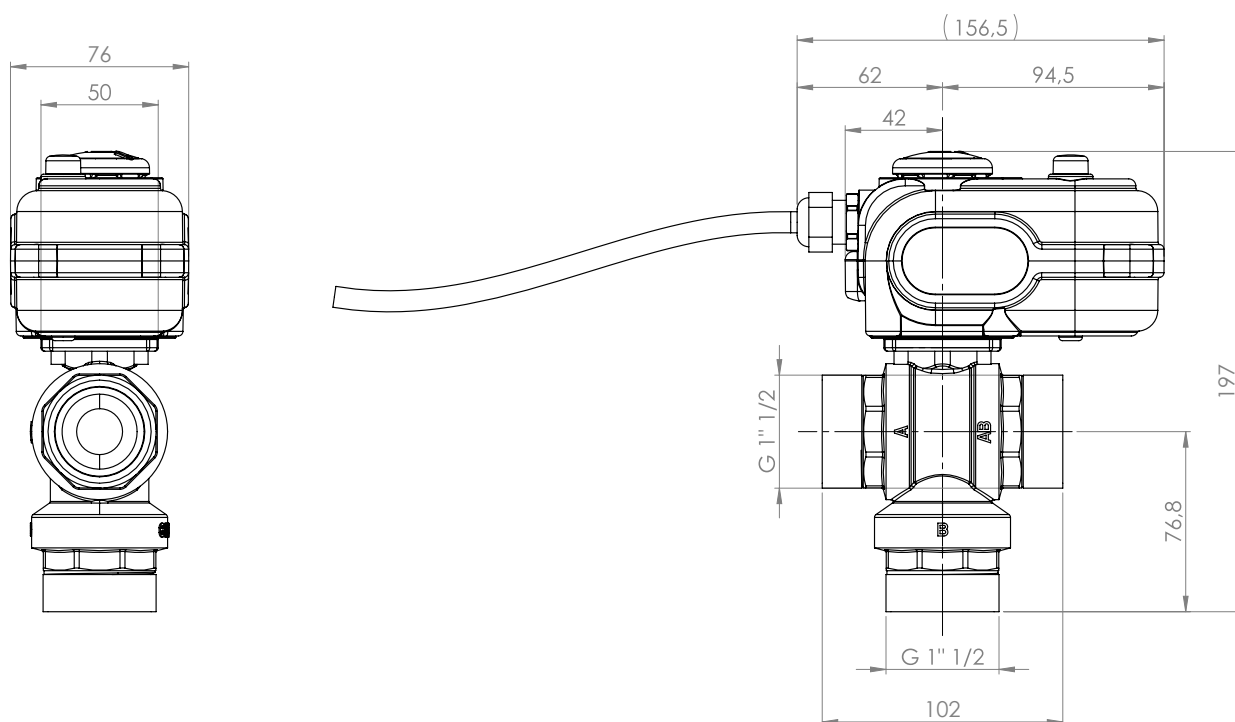

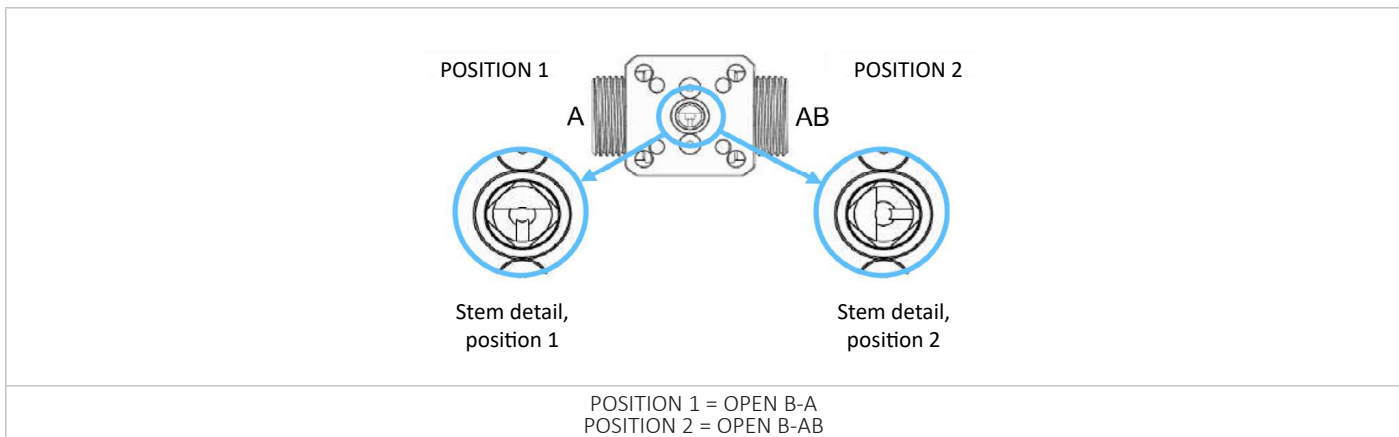

Permitted substances: water from -15°C to +110°C (below 0°C only for water with antifreeze additive).

Not suitable for group 1 and 2 gas, group 1 liquids (Directive 2014/68/EU)

Characteristics of servocontrol without spring return:

- Force [Nm]: 16
- Stroke time: 60 s
- Power supply 230 Vac
- IP rating: 65
- Valve body specifications:
- Frame: PN 40

Antifreeze thermal drain valve – valve able to open at 0°C to prevent the formation of ice inside the pipes.

Condensate drip tray - galvanised sheet metal container to be installed at the base of the unit for collecting condensate water from the unit.

Y-filter - contains a stainless steel mesh sieve (500 µm filtration) that collects solids in the water. Filtration prevents clogging and/or damage to devices installed downstream of the filter. Alternatively, it is possible to install a dirt separator which guarantees a filtration degree of no more than 1 mm (in this case, it is no longer necessary to install the Y-filter).

PSP - Solar panel probe for GI3 - probe required to measure the temperature of the solar panels if the unit is integrated with a solar thermal system.

FD - Dirt separator - blocks and retains the heaviest impurities in the hydraulic circuit, which are captured by a synthetic filtering grid and collected in a settling chamber. A magnetic device placed inside the body of the dirt separator also allows ferromagnetic particles to be intercepted.

Model i-290	MAXA code
0106, 0109	0119100075
0112, 0115, 0118	0119100076

The pressure drop curves of the component are shown:

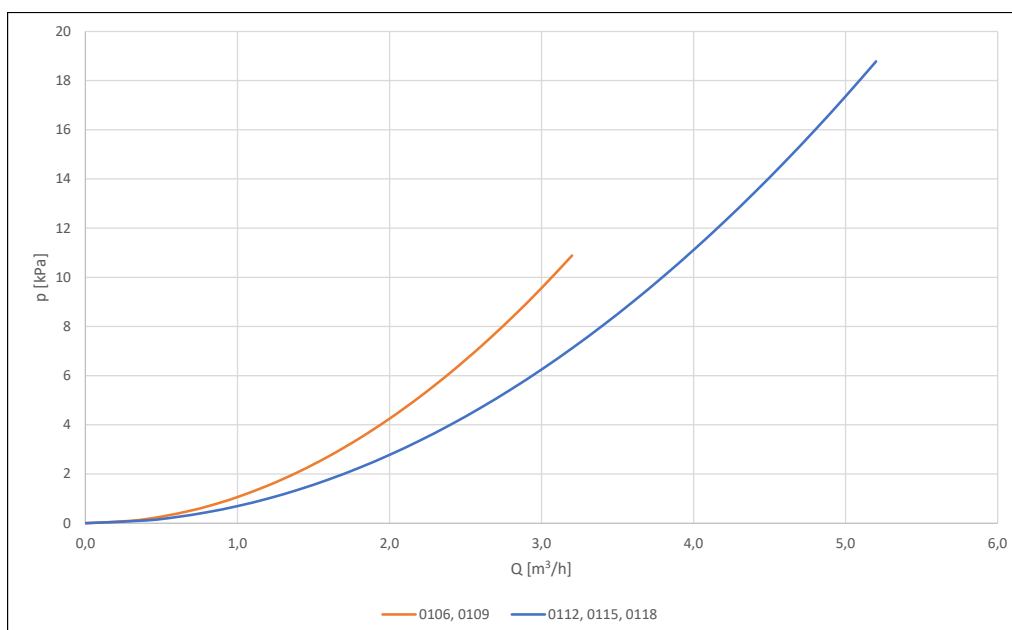

p [kPa]	Pressure drop
Q [m ³ /h]	Water flow rate

SAS - Domestic hot water probe / System remote probe - In some system solutions (e.g. heat pump in parallel to boiler on same hydronic circuit and shut off diverter valve) it might be necessary to enable a system temperature probe so that the machine controller can correctly process the control. The system remote probe controls the temperature of the heat pump only during the compressor start-up phase. Shutdown is managed by the probe on the heat pump delivery line.

Hi-T2 - Multi-purpose touch screen remote control - touch screen remote control for centralised management of a chiller/heat pump network. It includes humidity and temperature sensors for the thermal hygrometric analysis of the environment and for the management of the double set point for radiant floor heating systems that use a dehumidification system.

ISK - USB/RS485 Serial Converter - interface device capable of reading and writing control registers via the RS485 standard and converting it to a USB port that can be connected to any supervisory system.

LNC - LAN-Wi-Fi Router - device that allows the unit to be connected to a local network via Ethernet cable or Wi-Fi coverage for remote monitoring.

OVPN - 3G LAN-Wi-Fi router with VPN tunnel - device that allows the unit to be remotely connected with industrial routers using the secure OPENVPN service.

2.4 SAFETY RULES FOR R290 UNITS TRANSPORT AND STORAGE

Before opening the unit's packaging, ensure there are no gas leaks in the ambient with an appropriate gas detector. Check that there are no ignition sources near the unit.

No smoking near the unit.

Transport and storage must be performed in accordance with the national regulations in force. Specifically, according to ADR provisions, the total maximum quantity by transport unit in terms of net mass for flammable gases is 333 kg. In addition, for road transport, use vehicles that are preferably open or equipped with a ventilation system and operated by trained personnel.

For prerequisites on the transport by sea of equipment loaded with flammable refrigerant refer to the International Maritime Dangerous Goods Code (IMDG), and for transport by air check the regulations prescribed by the International Air Transport Organisation (IATA).

Please observe the following precautions:

- if storage is in a closed location, leave the machine in a dedicated place that is always dry, cool, well ventilated and protected from possible ignition sources, direct sunlight or other heat sources. It is also recommended to use one flammable gas detection sensor every 36-40 m². Please refer to national regulations;
- if storage is carried out in an open area, observe the minimum safety distances from drains, cisterns, sewers and other underground areas, in compliance with the national regulations in force;
- do not remove covers and packaging;
- ensure that all panels are correctly mounted;
- do not obstruct the openings and holes made in the machine panels;
- avoid cleaning the unit with aggressive detergents or chemicals;
- it is advisable to remove any heating water inside the unit to prevent possible corrosion or, in cold climates, damage to components caused by freezing.



CAUTION: During transport and storage of the unit, beware of possible refrigerant gas leaks that could start a fire.

3. INSTALLATION



CAUTION: All the operation described below must be done by **QUALIFIED PERSONNEL** only (IEC 60335-2-40 Annex HH). Before any operation on the unit, make sure that power supply is disconnected. Also ensure, by means of appropriate locks, that the power supply cannot be accidentally switched on again until all operations have been completed.

















3.1 GENERAL

When installing or working on the refrigeration circuit, it is necessary to comply with the regulations in this manual, observe the instructions on the unit and in any case apply all necessary precautions. Failure of this may lead to dangerous situations.



After receiving the unit, immediately check its integrity. The unit left the factory in perfect condition; any damage must be immediately reported to the carrier and recorded on the Delivery Note before signing it.

The company must be informed, within 8 days, of the extent of the damage. The customer should prepare a written statement of any severe damage.

	The units are designed to be installed outdoors. Under no circumstances should the outdoor ambient temperature exceed 46°C when the unit is not in operation. Above this value, the unit is no longer covered by current pressure equipment safety regulations.
	The installation place must be without any fire risks. All necessary measures must therefore be taken to prevent the risk of fire at the installation site (see Chapter 5.5 for more details). The device must not be placed in the vicinity of open flames, ignition sources or heat sources. The wall of the buildings near the unit must have an adequate fire resistance class, in order to contain any fire that may develop inside the rooms. However, it is recommended to place a fire extinguisher near the unit.
	The unit must be installed in order to allow maintenance and repair. The warranty does not cover costs for platforms or other lifting equipment needed for any interventions.
	All the maintenance operations and tests must be done by QUALIFIED PERSONNEL (IEC 60335-2-40 Annex HH). All equipment used during maintenance operations must be compatible with the refrigerant gas R290.
	Before any operation on the unit, make sure that the power supply is disconnected and cannot be switched on again accidentally. After disconnecting the power supply from the unit, wait at least 5 minutes before performing any operation on the machine to allow the condenser to discharge.
	Do not use equipment to speed up the defrost process or for cleaning except for those recommended by the manufacturer.
	The appliance must be placed outside, in a place without continuously operating ignition sources (e.g. open flames, an operating gas appliance or electric heater). Refer to Chapter 5.5.
	Cable ducts and electrical conduits to the machine must not contain potential ignition sources.
	Do not perforate or burn. Do not make mechanical modifications to the unit.
	There are some moving parts inside the unit. Use extreme caution when working near them, even if the power supply is disconnected. In particular, pay attention to the fan blades when removing the front protective grilles. Do not touch or insert any objects into the moving parts.
	The compressor heads and discharge pipework are at quite high temperatures. The pipes on the suction side of the compressor, can reach very low temperatures. Uninsulated pipes can cause burns or freezer burns: only handle these components when their temperature is close to ambient.
	Be particularly careful when working near batteries. Aluminium fins are very sharp and can cause serious injury.
	After the maintenance operations, close the panels by fixing them with screws.
	After maintenance or replacement of components, reconnect the cables in the same position as in the factory.
	Routine maintenance operations can be carried out with the machine charged, while in the case of extraordinary operations, repairs or replacement of components and heavy work in the vicinity of the machine (e.g. construction sites), drain the machine of coolant gas and move it to a safe area if necessary (in accordance with Chapter 5.5).
	Insulating materials are not self-extinguishing: remove them when working on the unit, if necessary.
	Do not remove, replace or make illegible the adhesive labels on the unit and packaging. Do not cover the labels after installation of the unit.

3.2 TRANSPORT AND STORAGE TEMPERATURE LIMITS

Minimum storage temperature [°C]	-10°C
Maximum storage temperature [°C]	+50°C

3.3 UNIT DIMENSIONS, PLUMBING CONNECTIONS AND WEIGHTS

3.3.1 Net dimensions and with packaging

Model i-290	Length [mm]	Width [mm]	Height [mm]	Plumbing connections IN/OUT	Dimensions with packaging (length x width x height) [mm]
0106 / 0109	1100	510	875	1" G	1195 x 580 x 920
0112 / 0115 / 0118	1100	510	1447	1" G	1195 x 580 x 1485

3.3.2 Models i-290 0106 / 0109

IN/OUT: 1" G
E: power supply input

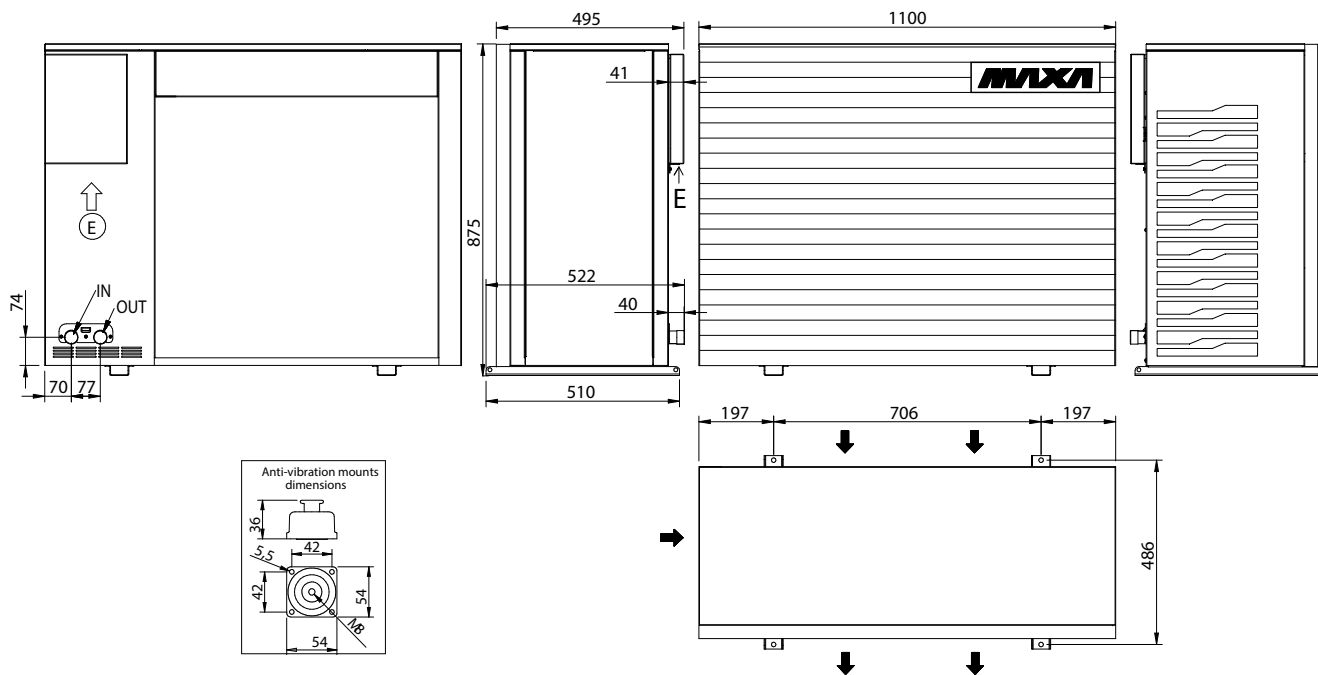

3.3.3 Models i-290 0112 / 0115 / 0118

IN/OUT: 1" G
E: power supply input

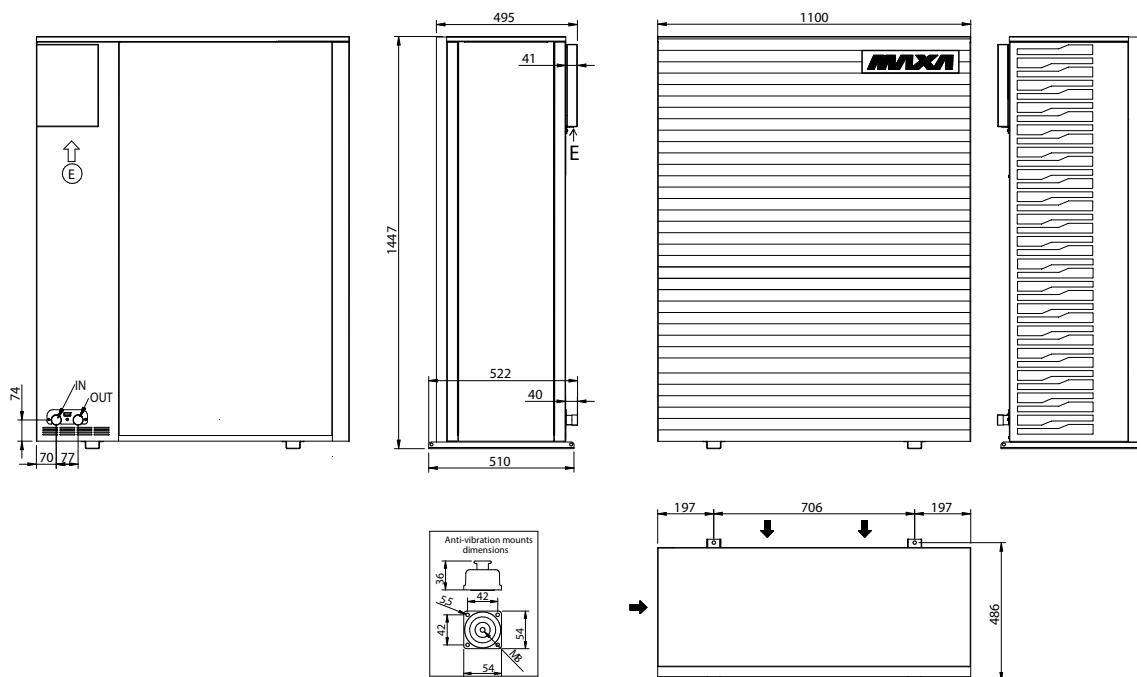

3.3.4 Weights

Model i-290	Shipping weight [kg]	Operating weight [kg]
0106	117	103
0109	119	105
0112	170	156
0115	188	174
0118	188	174



3.4 POSITIONING AND MINIMUM TECHNICAL CLEARANCES

All models of i-290 are designed and constructed for outdoor installations. The company is not liable for any damage to property, animals and/or persons resulting from failure to comply with the instructions on installing the unit described in this manual.

It is advisable to create an adequately sized support base for the unit. The units transmit a small amount of vibrations to the ground: however, it is advisable to place anti-vibration mounts between the base frame and the supporting surface. It is preferable to install the unit away from places sensitive to noise and vibration (e.g. windows and glass panes).

Always make an environmental impact assessment based on the power and sound pressure data in chapter "TECHNICAL DATA" and the sound emission limits according to the installation area of the unit, with reference to the DPCM of 14/11/1997. An assessment must also be made if the unit is installed near workers, according to D. LGS. 81/2008 Art. 189 and following. To reduce vibrations and noise, the use of rubber seals is recommended for wall installation.

	In case of hanging installation, it is necessary to make sure that the wall has been made with solid bricks, concrete or similar. The wall capacity needs to be enough to support at least four times the weight of the unit. The maximum installation height is 800 mm.
	The support plane must have enough capacity to support the unit weight, which can be checked both on the technical label of the unit and on this technical manual under "Technical data" chapter. The support plane must not be inclined to ensure the unit works properly and avoid a possible overturning. The support plane must not be smooth, to avoid water/ice deposit as potential sources of danger.
	Unit installation place must be free from foliage, dust, etc., which could clog or cover the coil. Installation in areas subject to water stagnation or fall, for example from gutters, should be avoided. Also, avoid areas subject to snow accumulation (such as corners of buildings with sloping roofs). In case of installation in areas subject to snowfall, it is advisable to place the unit on a base raised from the ground by 20-30 cm, to prevent the formation of snow accumulations around the machine, which can obstruct the battery and the perforations on the side panels and base of the machine.
	It is recommended that sufficient air exchange be ensured to dilute R290 gas in the event of its accidental escape, thus preventing the formation of explosive atmospheres. For this reason, a minimum distance (depending on the unit) must be maintained from any openings or manholes, in which the gas could accumulate. Respect national regulations for the installation of the machine.



	<p>The units are suitable for installation in urban, industrial, coastal and rural areas. If the unit is installed in an environment with aggressive atmospheres, the air sucked in by the fan may contain substances that can cause damage to the panels, grilles and internal components of the unit. In this case, the operating life of the unit will be limited.</p>
	<p>It is forbidden to install the unit under roofs of any kind, such as roofs, canopies, carports and the like, at a height of less than 1.5 m from the unit cover.</p>
	<p>It is prohibited to install the unit in a location below ground level (such as cellars, underground car parks, basement or underground work rooms, etc.).</p>

It is very important to avoid recirculation between intake and delivery air, so as not to downgrade performance of the unit or even to interrupt its normal operation.

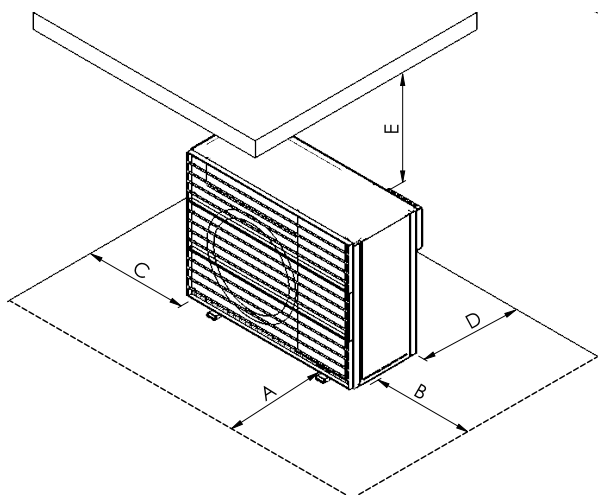
This is why the minimum clearances shown below must be strictly guaranteed.



MODEL i-290		A	B	C	D	E
i-290 0106	mm	1500	500	400	400	1500
i-290 0109	mm	1500	500	400	400	1500
i-290 0112	mm	1500	500	400	400	1500
i-290 0115	mm	1500	500	400	400	1500
i-290 0118	mm	1500	500	400	400	1500

	<p>Obstruction or covering of ventilation openings on the top cover must be avoided.</p>
	<p>For strong wind installation place refer to the classification of the area according to the Beaufort table. If the value is > 7 (strong wind, average wind speed = 13, 9-17, 1 m/s) it is strictly necessary to keep the fan always powered, thus preventing involuntary rotation of the same.</p>
	<p>If the unit is installed at a distance of less than 1 km from coastal and maritime areas, the presence of salt and sand in the air greatly increases the likelihood of corrosion. Install the unit so that it is protected from direct sea wind if necessary, provide windbreaks on site (observing the minimum distances indicated).</p>

In the event of side-by-side units, the minimum Lmin distance between them is 1 m

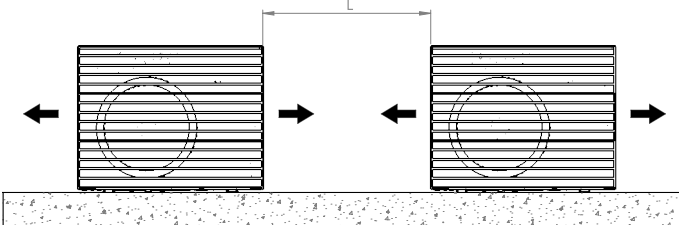

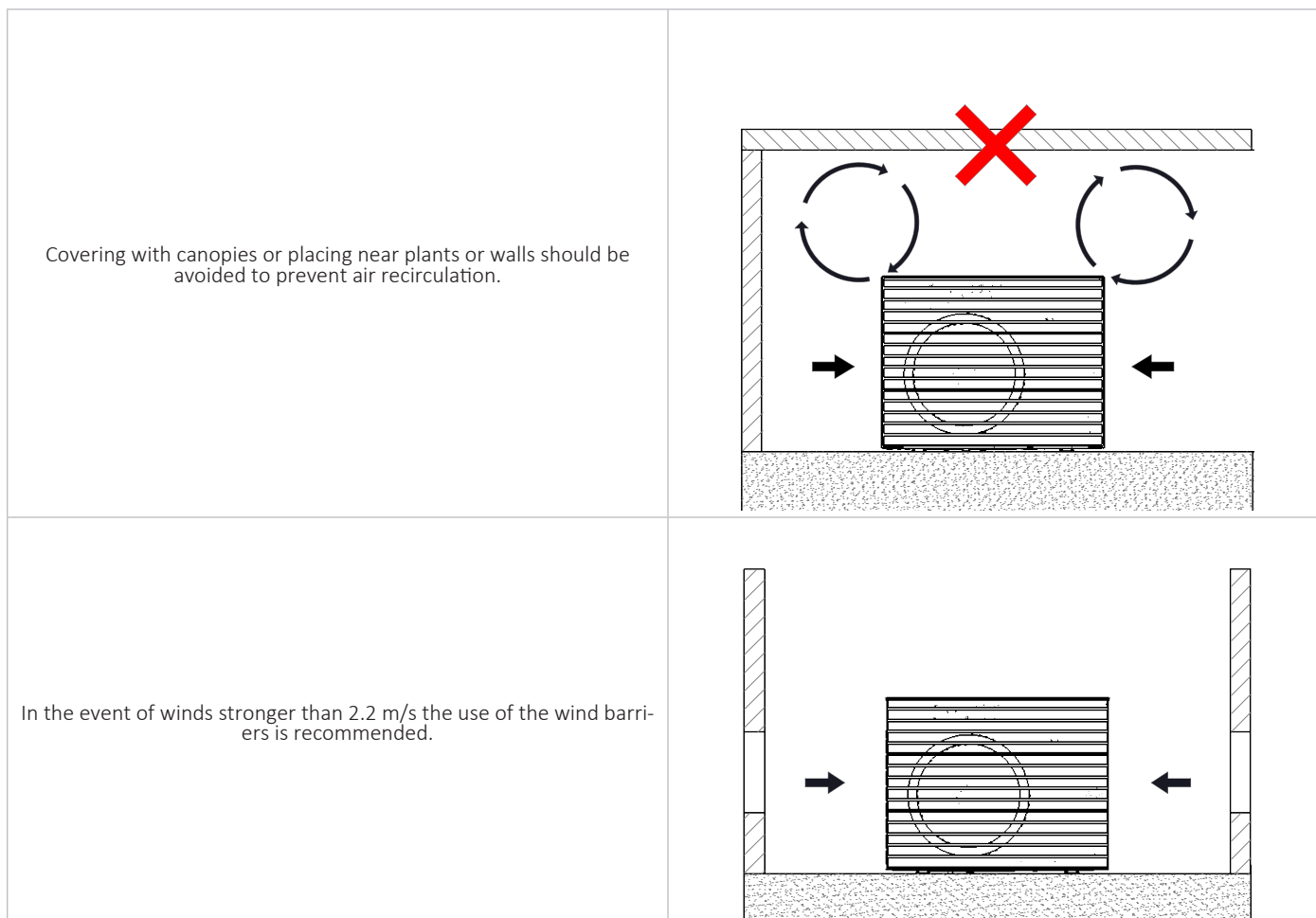

3.5 DANGER AND SAFETY ZONES

The i-290 series units contain R290 refrigerant gas. The density of this gas is greater than that of air, so in the event of leakage it tends to disperse and stratify, accumulating in niches, depressions in the ground or underground regions.

It is mandatory to comply with the danger and safety zones given in this manual, when installing the units. These zones have been designed in accordance with EN 60079-10-1, estimating an appropriate refrigerant loss, in order to guarantee the safety of the units in the installation area. A **danger zone** is defined as a area around the machine in which, in the event of a leakage of refrigerant gas, a flammable atmosphere is formed for a short time, within which it is necessary to implement all the precautions described in the manual. In the absence of specific standards or regulations, when using the unit in an industrial or working environment, it is advisable to carry out the classification of places with explosion hazards considering the ATEX Directive 1999/92 (Directive 89/391). There must NOT be any sources of ignition in the danger zones, including:

- flammable gases and sprays, self-igniting powders;
- electrical equipment that is not suitable for use in potentially explosive areas (zone 2 according to Directive 89/391);
- naked flames, heated surfaces (maximum surface temperature of 360°C) and processing by heat; smoking is prohibited, including for electronic cigarettes;
- sparks, electrostatic charges, direct and indirect lightning effects, eddy currents and cathodic protection;
- ignition sources due to remote processes (ionising and non-ionising radiation);
- permanent electrical sources (switches, lamps, etc.) or other possible triggers;

In addition, danger zone must NOT:

- include potentially dangerous areas or elements such as wells, manholes, openings to the sewage system and other openings to underground places and premises (e.g. garages), river drains, power lines, flammable deposits, electrical installations, etc.;
- include doors, windows or glass panes, to prevent the possible return of the gas inside the building;
- extending towards neighbouring residential properties, parking areas, public access sites, roads or railways.

A **safety zone** extending beyond the danger zone must also be identified. Within the safety zone, in the event of a refrigerant leak, the concentration of the gas in the air is typically below the critical levels for the formation of flammable or hazardous atmospheres. Compliance with the following provisions remains mandatory:

- prevent accumulation and stagnation in underground spaces, drains, manholes, cellars, etc.;
- do not place building vents inside or near the safety zone;
- do not use naked flames and other direct heat sources.

In any case, comply with national and local regulations for the installation of machinery (where applicable) in order to prevent the formation of fire hazards and to prevent gases from seeping underground into openings to the ground or floors below.

No structural modifications may be made in the danger and safety zones that would alter their extent or change the behaviour of the air-coolant mixture.

It is also strictly forbidden to tamper with, alter, remove or compromise, even partially, the functionality of the devices, guards and prescriptions provided for the safety of property and persons.

In this manual, different types of outdoor installation are considered, as indicated in the following paragraphs.

3.5.1 Free-field ground installation

For unit installed in open field terrain, the danger (continuous red line) and safety zones (dashed black line) are shown in the figures below:

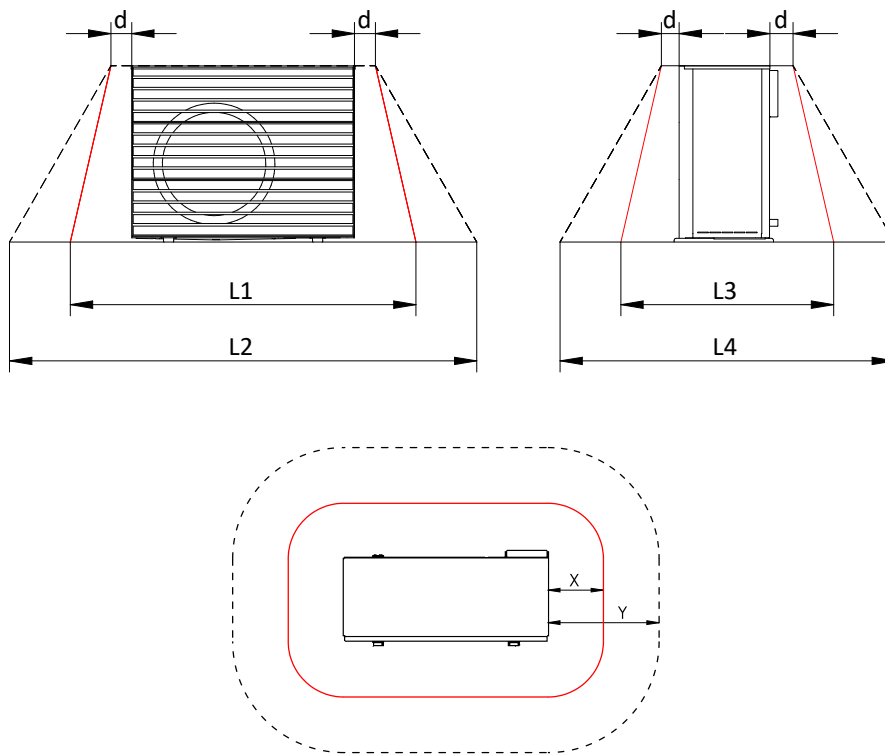

MODEL i-290		X	Y	L1	L2	L3	L4	d
0106 / 0109	mm	1000	1500	3105	4105	2490	3490	250
0112 / 0115 / 0118	mm	1500	2000	4105	5105	3490	4490	250

3.5.2 Ground installation in front of a wall

In the case of units installed on the ground in front of a wall, the danger (continuous red line) and safety zones (dashed black line) are shown in the figures below:

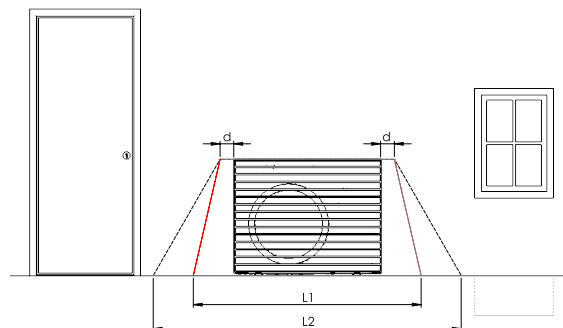

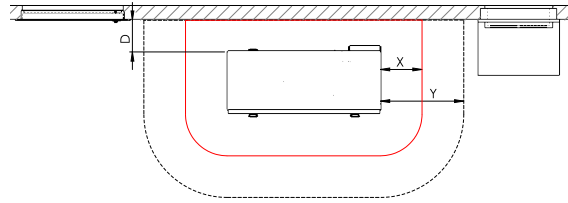

MODEL i-290		X	Y	L1	L2	D	d
0106 / 0109	mm	1000	1500	3105	4105	400	250
0112 / 0115 / 0118	mm	1500	2000	4105	5105	400	250

3.5.3 Ground installation in a corner

For units installed on ground in a corner, the danger (continuous red line) and safety zones (dashed black line) are shown in the figures below:

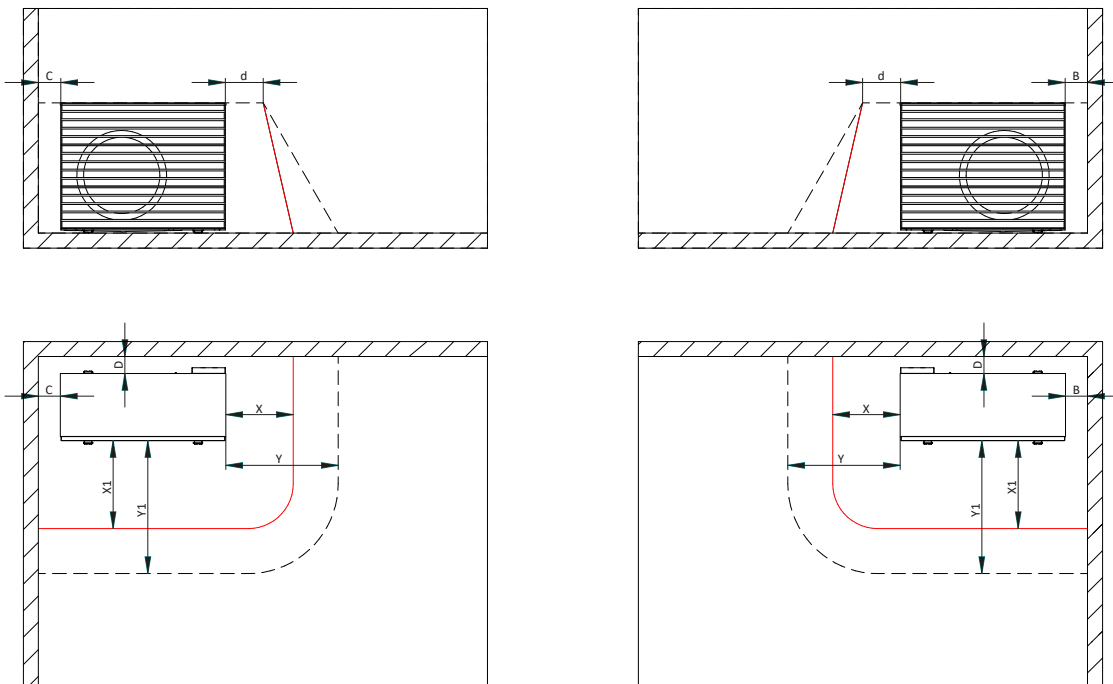

MODEL i-290		X	Y	X1	Y1	B	C	D	d
0106 / 0109	mm	1000	1500	2000	2500	500	400	400	250
0112 / 0115 / 0118	mm	1500	2000	2750	3250	500	400	400	250

3.5.4 Flat roof installation

The installation configuration on a flat roof is similar to that on a free-field ground, although some additional aspects must be considered:

- place the machine at a sufficient distance from side walls and protrusions, which must therefore be beyond the safety zone;
- ensure that the roof structure of the building is solid;
- choose a location where no accumulations of snow, dust or foliage can form;

- pay attention to noise emissions and maintain an adequate distance from surrounding buildings;
- if high air velocities are detected, install the protections listed in the previous chapter.

3.5.5 Multiple installation

When installing several machines side by side, follow the above configurations, maintaining a respect distance of L between each machine. As an example, see the following respect zones (danger and safety) for the case of a generic number "n" of units installed on open field terrain:

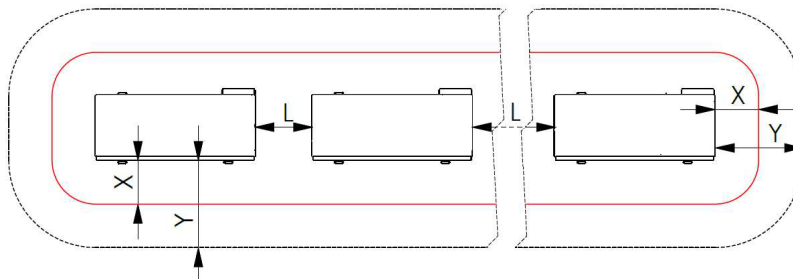

MODEL i-290		X	Y	L
0106 / 0109	mm	1000	1500	1000
0112 / 0115 / 0118	mm	1500	2000	1000

For other types of installation not covered in this manual, contact technical support. If in doubt about the installation of the units, request a technical assessment by the fire brigade or a fire prevention expert.

3.6 PLUMBING CONNECTIONS

The plumbing connections must be made in accordance with national and/or local regulations; pipes can be made of steel, galvanised steel, multilayer steel or PVC. Pipes must be accurately sized according to the maximum water flow rate of the unit and the pressure drops of the water circuit. All pipes must be insulated with closed-cell material of adequate thickness. The chiller must be connected to the pipes using new flexible joints, not reused ones. The water circuit should include the following components.

- Well thermometers to monitor the circuit's temperature.
- Manual gate valves to isolate the chiller from the water circuit.
- Metal Y filter or a dirt separator (installed on the return pipe) with metal mesh no larger than 1 mm.
- Loading group and exhaust valve where necessary.



When sizing the pipes, make sure not to exceed the maximum pressure drop on system side reported in the technical data table in Chapter 12 (see useful head).

Connect the pipes to their fittings always using the key-to-key method.

Create a suitable drain for the safety valve.

CAUTION: The installer has to verify if the expansion tank fits with the real capacity of the installation.

CAUTION: The return pipe from the system must be at the "WATER INPUT" label otherwise the evaporator may freeze.

CAUTION: It is mandatory to install a metal filter (with mesh no larger than 1 mm) on the return pipe from the system labelled "WATER INLET". Alternatively, it is possible to install a dirt separator that guarantees a filtration degree of no more than 1 mm; in this case is not necessary to install the Y-filter. If the flowmeter is tampered with or altered, or if the metal filter or the dirt separator are not present on the system, the warranty shall expire. The filter (or the dirt separator) must be kept clean, therefore, after installing the unit, you must make sure that they are still clean and check them regularly.

CAUTION: All the units leave the company supplied with flowmeter (installed in factory). If the flowmeter is altered or removed or if the water filter and dirt separator are missing from the unit, the guarantee shall expire. Refer to the wiring diagram attached to the unit to connect the flowmeter. Never jumper connections of the flowmeter in the terminal block.

The heating system and the safety valves must comply with the requirements of standard EN 12828.

3.6.1 Characteristics of the circuit water

To guarantee correct operation of the unit, the water must be appropriately filtered (see the instructions at the start of this paragraph) and there must be only a minimum amount of dissolved substances. The maximum allowed values are shown below:

MAXIMUM CHEMICAL-PHYSICAL PROPERTIES ALLOWED FOR THE CIRCUIT WATER

PH	7,5 - 9
Electrical conductivity	100 - 500 $\mu\text{S}/\text{cm}$
Total hardness	4,5 – 8,5 dH
Temperature	< 75°C
Oxygen content	< 0,1 ppm
Max glycol quantity (*)	10 %
Phosphates (PO_4)	< 2 ppm
Manganese (Mn)	< 0,05 ppm
Iron (Fe)	< 0,3 ppm
Alkalinity (HCO_3)	70 – 300 ppm
Chloride ions (Cl^-)	< 50 ppm
Sulphate ions (SO_4)	< 50 ppm
Sulphide ions (S)	No one
Ammonium ions (NH_4)	No one
Silica (SiO_2)	< 30 ppm

(*) It is preferable to use pure water. Do not add more antifreeze than the maximum quantity specified in this manual.

3.6.2 Typical plumbing diagram

Refer to the "Handbook" for further information regarding possible unit installation configurations.

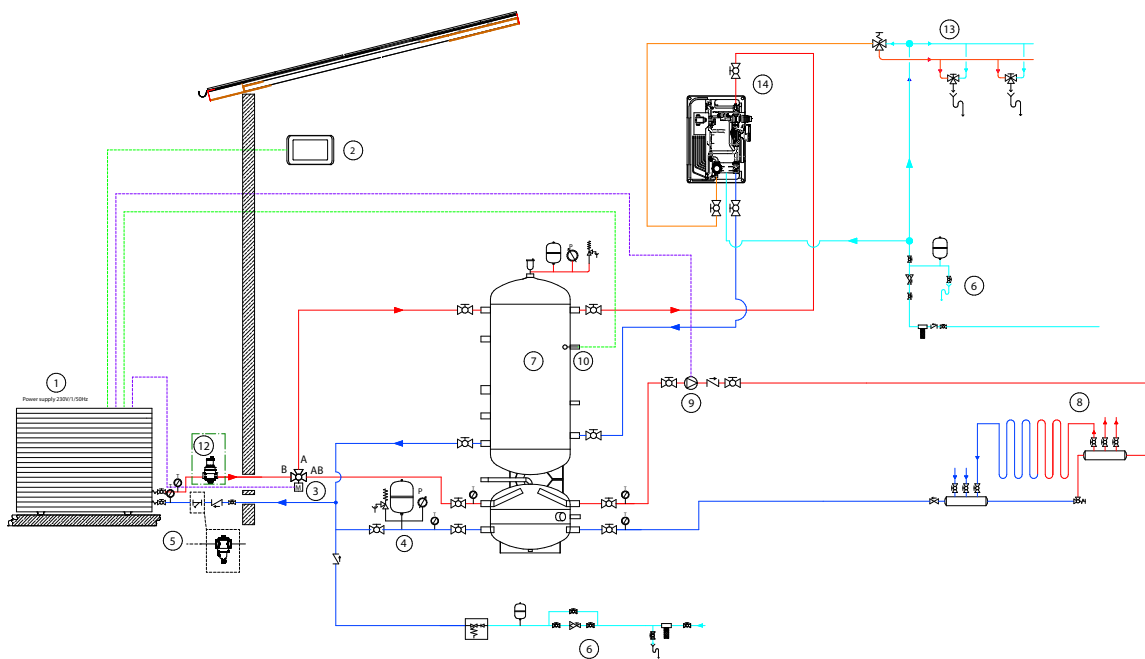

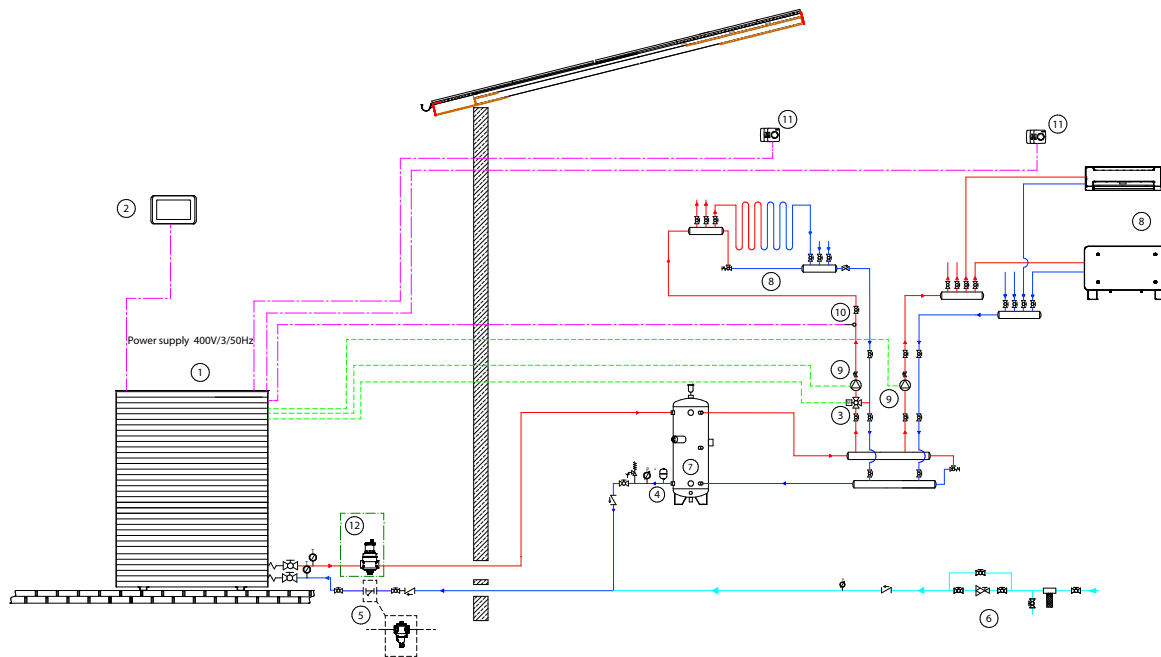

Num.	Description
1	Heat pump
2	Remote control
3	Mixing valve
4	Expansion tank
5	Y-filter or Dirt separator with integrated filter
6	Water supply
7	Technical storage
8	Hydronic terminals
9	Booster pump
10	Mixing probe
11	Local thermostat
12	Deaerator
13	DHW
14	Boiler

3.6.3 Minimum water content and hydraulic circuit volumes

The table shows the minimum system water content recommended for the unit. The volume of the hydraulic circuit is also indicated. To ensure proper operation of the heat pump, this minimum content must be met. Taking into consideration the volume of water in the primary circuit piping, size the thermal flywheel to achieve the indicated volume.

Model i-290	06	0109	12	0115	0118
Minimum system water content [L].	65	95	125	155	155
Hydraulic circuit volume [L]	2,1	2,9	3,5	3,5	3,5

3.6.4 Plumbing diagram inside unit

The unit plumbing connection diagrams are provided below.

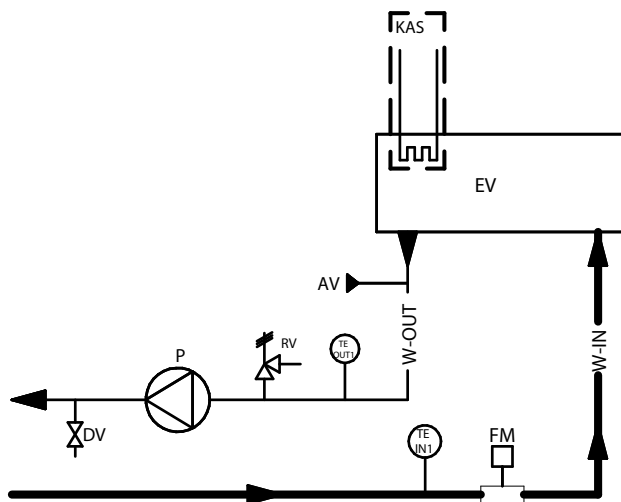

Models i-290 0106, 0109, 0112, 0115, 0118

KAS	HEAT EXCHANGER ANTIFREEZE RESISTOR
TE IN	UTILITY INLET TEMPERATURE PROBE
TE OUT	UTILITY OUTLET TEMPERATURE PROBE
DV	DRAIN VALVE
RV	SAFETY VALVE
FM	FLOWMETER
P	PUMP
AV	AUTOMATIC AIR VENTING VALVE
DA	DEAERATOR

3.6.5 Condensation drain system

All units of i-290 series are built in such a way that the base of the unit acts as a condensate drip tray. A plastic fitting is supplied as standard, to be connected underneath the base in the special provision for connecting a drain pipe to channel condensate.

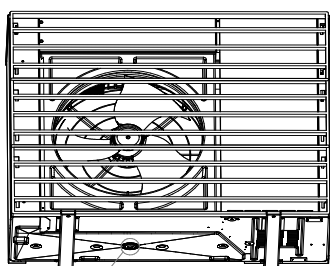

Hole in bottom panel of outdoor unit

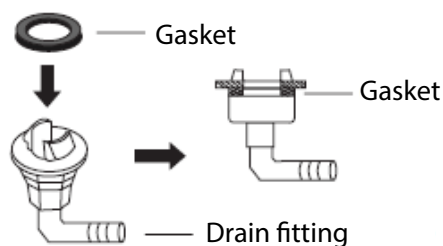

Each unit is fitted with a hole on the base of the hydronic kit (on the side of the coil) for draining any condensation that may percolate from the plumbing pipes and water formed as a result of the defrosting process. The pipes are well insulated, condensation production is minimal. In the event of a leakage, refrigerant gas can escape from the unit through the hole in the base panel, so it is recommended that the condensate drain is always directed to an open place near the unit (within the danger zone defined in Chapter 5.5). If the unit is installed on the ground, it is also possible to direct the condensation into a bed of rubble or gravel for drainage. For typical free-field ground installation, please refer to the following pictures:

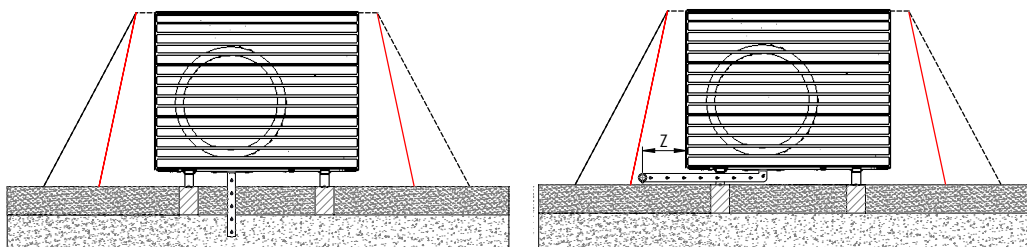

MODEL i-290		z
0106 / 0109 / 0112 / 0115 / 0118	mm	< 250

Caution: Do not obstruct the hole in the base panel for condensate drainage.

Especially in very cold climate regions, it is recommended to install elevation supports in order to allow ice formation under the unit without damaging it by freezing.



When outside air temperatures fall below 0 °C, to prevent condensation from freezing, a heating resistor should be installed on the exhaust pipe. In this case, the heating element must be compatible with R290 refrigerant gas.

3.6.6 System load



- CAUTION: Supervise all filling/reintegration operations.
- CAUTION: Before filling/reintegration the system, disconnect power to the units.
- CAUTION: The filling / reintegrating of the system must always take place under controlled pressure (max. 1). Ensure that a pressure reducer and safety valve is installed on the filling/reintegration line.
- CAUTION: The water in the filling/reintegration line must be properly pre-filtered from impurities and suspended particles. Ensure that a removable cartridge filter and a dirt separator are installed.
- CAUTION: Regularly check and vent the air built up in the system.
- CAUTION: Install an automatic air venting valve at the highest point of the system.

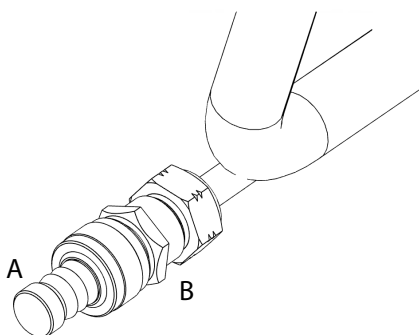

If it is necessary to top up the system or adjust the glycol content, the service tap can be used. Unscrew the cap of the service tap (A) and connect a pipe of 14 or 12 mm (inertial diameter measurements - check the tap model installed on your unit) connected to the water mains to the hose connector, then fill the system by unscrewing the ring nut (B). Once the operation is completed, tighten the ring nut (B) again and screw the cap (A). In any case, it is advisable to use an external tap to fill the system.

3.6.7 System discharge

If the unit needs to be drained completely, first close the manual inlet and outlet gate valves (not included in supply) and then detach the pipes on the outside of the water inlet and outlet to drain liquid from the unit (to make this operation easier, it is recommended to install two drain valves between the unit and manual gate valves on the outside of the water inlet and outlet).

4. GENERAL TECHNICAL DATA

4.1 STANDARD UNIT DATA TABLE

TECHNICAL CHARACTERISTICS		Unit of measurement	i-290			
			0106	0109	0112	
Cooling	Cooling capacity (1) min/nom/max	kW	2,10 / 5,43 / 5,78*	3,27 / 8,57 / 9,20*	4,20 / 10,67 / 11,21*	
	Input power (1)	kW	1,95	2,77	3,75	
	EER (1)	W/W	2,79	3,09	2,85	
	Cooling capacity (2) min/nom/max	kW	3,29 / 5,62 / 6,19*	4,88 / 9,15 / 9,89*	6,30 / 12,57 / 13,25*	
	Input power (2)	kW	1,25	1,93	2,83	
	EER (2)	W/W	4,48	4,75	4,44	
	SEER (5)	W/W	4,77	5,41	4,72	
	Water flow rate (1)	L/s	0,26	0,40	0,49	
	User side heat exchanger pressure drops (1)	kPa	7,8	5,1	7,5	
	Nominal useful head (1)	kPa	65,7	57,3	81,2	
Heating	Heating capacity (3) min/nom/max	kW	2,97 / 6,24 / 6,86*	4,12 / 9,69 / 10,42*	5,99 / 12,6 / 13,7*	
	Input power (3)	kW	1,31	2,05	2,61	
	COP (3)	W/W	4,76	4,72	4,83	
	Heating capacity (4) min/nom/max	kW	2,74 / 5,97 / 6,42*	3,63 / 9,10 / 9,75*	5,26 / 11,61 / 12,77*	
	Input power (4)	kW	1,91	2,85	3,60	
	COP (4)	W/W	3,12	3,20	3,22	
	Heating capacity (11) min/nom/max	kW	2,62 / 5,87 / 6,41*	3,36 / 9,05 / 9,81*	4,93 / 12,04 / 13,08*	
	Input power (11)	kW	2,29	3,40	4,60	
	COP (11)	W/W	2,57	2,66	2,62	
	SCOP (6)	W/W	4,74	5,19	4,88	
	Water flow rate (3)	L/s	0,29	0,44	0,58	
	User side heat exchanger drops (3)	kPa	9,6	6,2	10,5	
	Nominal useful head (3)	kPa	63,6	52,8	79,5	
	Energy efficiency water 35°C / 55°C	Class	A+++/A++	A+++/A+++	A+++/A++	
	Compressor	Type		Twin Rotary DC Inverter		
		Refrigerant oil (type)	A	PZ46M	PZ46M	PZ46M
Number of compressors		n°	1	1	1	
Oil charge (quantity)		L	0,45	0,52	0,90	
Refrigerant	Type		R290			
	Refrigerant charge (7)	kg	0,43	0,75	1,00	
	Amount of refrigerant in equivalent CO2 tonnes (7)	ton	0,000	0,000	0,000	
	Design pressure (high/low) heat pump mode	bar	30,3/0,3	30,3/0,3	30,3/0,3	
Design pressure (high/low) chiller mode	bar	30,3/2	30,3/2	30,3/2		
Fans	Type		Brushless DC motor			
	Number	n°	1	1	2	
Internal heat exchanger	Internal heat exchanger type		Plates			
	N° internal heat exchangers	n°	1	1	1	
Hydraulic circuit	Water content	L	0,94	1,69	1,69	
	Water content of hydronic circuit	L	2,2	2,2	3,7	
	Maximum water side pressure	bar	3	3	3	
	Plumbing fittings	inch	G1"	G1"	G1"	
	Minimum water volume (8)	L	65	95	125	
	Maximum circulator output	kW	0,095	0,095	0,14	
Noise level	Maximum circulator absorbed current	A	0,7	0,7	1,2	
	Sound power level Lw (9)	dB(A)	57	58	59	
	Sound pressure at 1m distance Lp1 (10)	dB(A)	42	43	44	
Electrical data	Sound pressure at 10m distance Lp10 (10)	dB(A)	26	27	28	
	Power supply		230V/1/50Hz			
	Maximum input power	kW	2,9	4,4	5,1	
	Maximum input current	A	14,4	21,4	25,8	
	Maximum input power with antifreeze kit	kW	3,0	4,6	5,3	
Maximum input current with antifreeze kit	A	15,0	22,0	26,4		

TECHINCAL CHARACTERISTICS		Unit of measurement	i-290	
			0115	0118
Cooling	Cooling capacity (1) min/nom/max	kW	5,11 / 12,41 / 13,47*	5,11 / 13,75 / 14,33*
	Input power (1)	kW	3,71	4,34
	EER (1)	W/W	3,35	3,16
	Cooling capacity (2) min/nom/max	kW	7,86 / 12,9 / 14,40*	7,90 / 13,94 / 14,79*
	Input power (2)	kW	2,40	2,69
	EER (2)	W/W	5,37	5,18
	SEER (5)	W/W	5,02	5,04
	Water flow rate (1)	L/s	0,57	0,66
	User side heat exchanger pressure drops (1)	kPa	11,7	16,0
	Nominal useful head (1)	kPa	79,7	73,5
Heating	Heating capacity (3) min/nom/max	kW	7,17 / 16,33 / 17,69*	7,21 / 18,72 / 19,84*
	Input power (3)	kW	3,30	4,05
	COP (3)	W/W	4,94	4,62
	Heating capacity (4) min/nom/max	kW	6,58 / 15,23 / 16,64*	6,60 / 17,38 / 18,65*
	Input power (4)	kW	4,52	5,32
	COP (4)	W/W	3,37	3,27
	Heating capacity (11) min/nom/max	kW	6,20 / 14,65 / 15,94*	6,15 / 16,65 / 17,73*
	Input power (11)	kW	5,17	6,04
	COP (11)	W/W	2,83	2,76
	SCOP (6)	W/W	4,85	4,76
	Water flow rate (3)	L/s	0,78	0,87
	User side heat exchanger pressure drops (3)	kPa	22,0	27,8
	Nominal useful head (3)	kPa	66,8	59,8
	Energy efficiency water 35°C / 55°C	Class	A+++/A++	A+++/A++
	Compressor	Type		Twin Rotary DC Inverter
Refrigerant oil (type)		A	PZ46M	PZ46M
Number of compressors		n°	1	1
Oil charge (quantity)		L	0,9	0,9
Refrigerant	Type		R290	
	Refrigerant charge (7)	kg	1,27	1,27
	Amount of refrigerant in equivalent CO2 tonnes (7)	ton	0,000	0,000
	Design pressure (high/low) heat pump mode	bar	30,3/0,3	30,3/0,3
Design pressure (high/low) chiler mode	bar	30,3/2	30,3/2	
Fans	Type		Brushless DC motor	
	Number	n°	2	2
Internal heat exchanger	Internal heat exchanger		Plates	
	N° internal heat exchanger	n°	1	1
Hydraulic circuit	Water content	L	1,69	1,69
	Water content of hydronic circuit	L	3,7	3,7
	Maximum water side pressure	bar	3	3
	Plumbing fittings	inch	G1"	G1"
	Minimum water volume (8)	L	155	155
	Maximum circulator output	kW	0,14	0,14
Noise level	Maximum circulator absorbed current	A	1,2	1,2
	Sound power level Lw (9)	dB(A)	62	62
	Sound pressure at 1m distance Lp1 (10)	dB(A)	47	47
	Sound pressure at 10m distance Lp10 (10)	dB(A)	31	31
Electrical data	Power supply		400V/3/50Hz	
	Maximum input power	kW	7,7	8,2
	Maximum input current	A	15,8	16,5
	Maximum input power with antifreeze kit	kW	7,9	8,3
Maximum input current with antifreeze kit	mm	16,4	17,1	

Performance referring to the following conditions, according to standard UNI EN 14511:2022:

- (1) Cooling: outdoor air temperature 35°C; in/out water temperature 12/7°C.
 - (2) Cooling: outdoor air temperature 35°C; in/out water temperature 23/18°C.
 - (3) Heating: outdoor air temperature 7°C db 6°C db; in/out water temp 30/35°C.
 - (4) Heating: outdoor air temperature 7°C db 6°C db; in/out water temp 47/55°C.
 - (5) Cooling: low temperature,variable output, fixed flow rate.
 - (6) Heating: average climatic conditions; T_{biv}=-7°C; low temperature,variable output, fixed flow rate.
 - (7) Indicative data subject to changes. For the correct value, always refer to the technical label on the unit.
 - (8) Calculated for a decrease in system water temperature of 10°C with a defrost cycle lasting 6 minutes.
 - (9) Sound mode: heating mode according to EN 12102:2022 Annex A; value determined on the basis of measurements made in accordance with UNI EN ISO 9614-1, in compliance with Eurovent certification requirements.
 - (10) Sound pressure: value calculated from the sound power level in condition (9) using the standard UNI EN ISO 3744:2010.
 - (11) Heating: outdoor air temperature 7 °C b.s. 6 °C b.u.; inlet/outlet water temp. 55/65°C.
- (*) activating the maximum Hz function.

N.B. performance data are indicative and are subject to change. Furthermore the performance declared in points (1), (2), (3) and (4) is intended to refer to instantaneous power according to EN 14511:2022. The value declared in point (5) and (6) is determined according to UNI EN 14825:2022.

4.2 ELECTRICAL AND AUXILIARY DATA

Power supply	V/~ /Hz	230/1PH+PE/50*- 400/3PH+PE/50**	Remote controller circuit	V/~ /Hz	12/1/50
On board controller circuit	V/~ /Hz	12/1/50	Fans power supply	V/~ /Hz	230/1/50

(*) For sizes 0106,0109,0112. - (**) For sizes 0115, 0118

NOTE: The electrical data are subject to change due to updates. It is therefore always necessary to refer to the technical specifications label applied on the right side panel of the unit.

5. CORRECTION FACTORS

5.1 CORRECTION FACTORS FOR USE OF GLYCOL WATER MIXTURE

The correction factors of the water flow rate and pressure drops must be applied to the values obtained without use of glycol. The correction factor for the water flow rate is calculated to maintain the same temperature difference which would be achieved without the use of glycol.

Glycol percentage	Freezing point [°C]	Performance correction factor	Absorbed power correction factor	Water flow rate correction factor	Pressure drops correction factor
10%	-3,2	0,992	1,01	1,03	1,11



Do not add more glycol than the maximum quantity indicated in this manual, as this may severely restrict the deaerator's ability to remove gases, possibly resulting in damage to the component.

5.2 SCALING CORRECTION FACTORS

The correction factors due to fouling of the internal gas/water heat exchanger are reported below.

m ² °C/kW	Output power correction factor	Input power correction factor
0,44 x 10 ⁻¹	1,00	1,00
0,88 x 10 ⁻¹	0,99	1,00
1,76 x 10 ⁻¹	0,98	1,00

5.3 INSTRUMENTATION CALIBRATIONS AND PROTECTIONS

Description	Value
High pressure switch	31,5 bar
High pressure alarm	30,3 bar
Low pressure alarm - heating	0,3 bar
Low pressure alarm - cooling	2,0 bar
Maximum number of restarts/hour after high/low	3
Antifreeze protection	Allarm triggered: 3°C Allarm return: 5°C
Hydronic circuit safety valve	3 bar

5.4 CORRECTION FACTORS ACCORDING TO ALTITUDE

The performance correction factors according to altitude are calculated for cooling at conditions (1) and for heating at conditions (3) of the previous technical data tables and are provided for altitudes of 500, 1000, 1500 and 2000 m.

i-290				
Altitude [m]	500	1000	1500	2000
Thermal output correction factor	0,9992	0,9979	0,9970	0,9958
Power input correction factor in heating	0,9985	0,9962	0,9939	0,9916
Cooling output correction factor	0,9961	0,9873	0,9796	0,9746
Power input correction factor in cooling	1,0021	1,0103	1,0149	1,0205

6. HYDRONIC UNIT DATA

6.1 USEFUL HEADS

The following are the characteristic curves of the head-flow rate net of the pressure drops of the hydronic kit. The optimal operating point at the apex (3) in the technical data table is highlighted on each curve. The system must be designed to guarantee the nominal flow rate relative to the working points shown below.

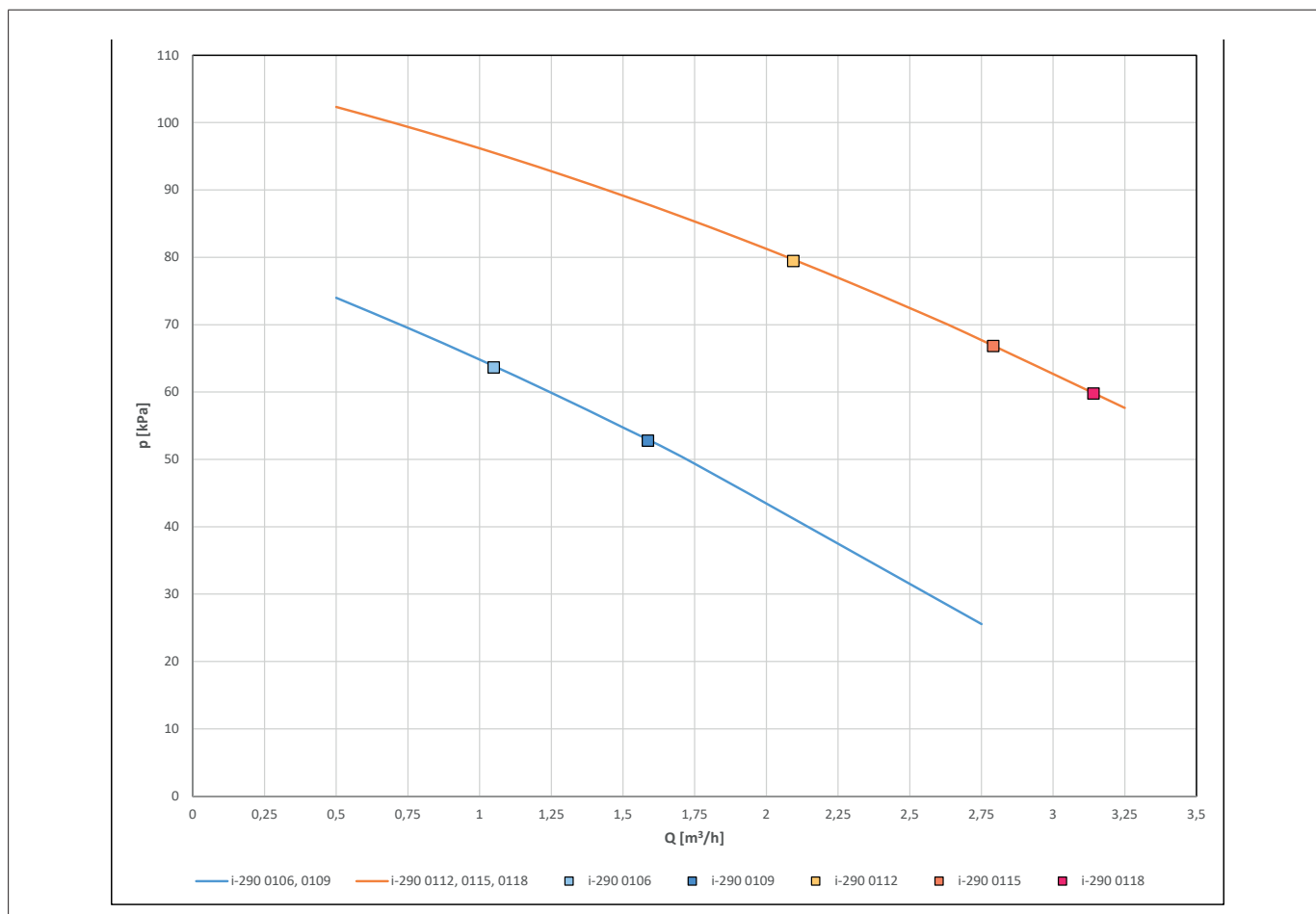

p [kPa] Useful head
Q [m³/h] Water flow rate

6.2 CHARACTERISTIC CURVES OF CIRCULATORS

Below is the range of useful heads which guarantee the unit during modulating of the circulator.

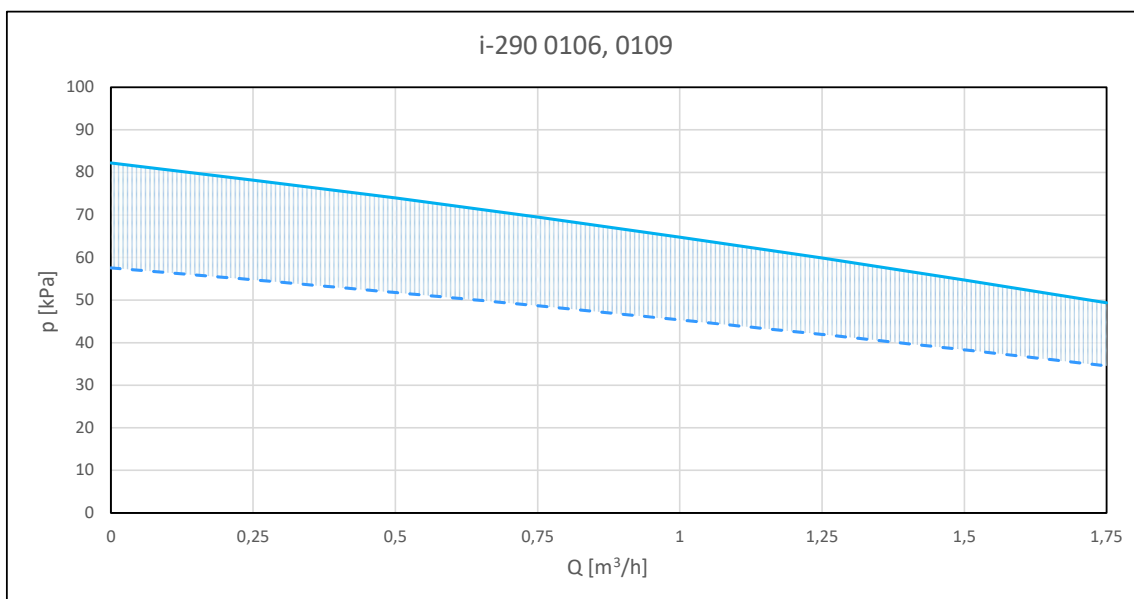

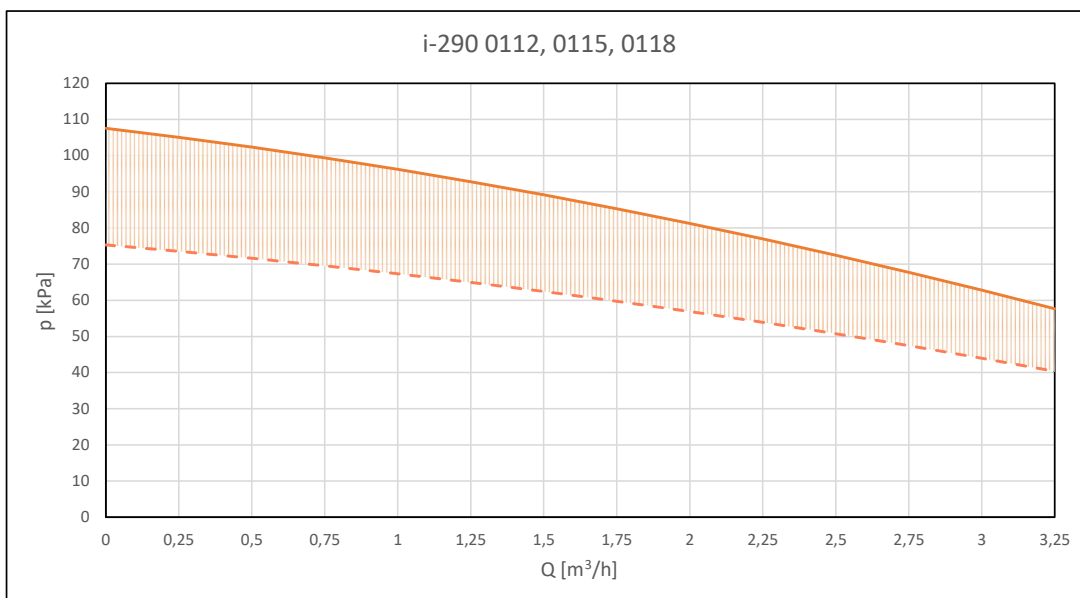

7. SOUND EMISSIONS ACCORDING TO EN 12102-1:2022

7.1 FULL LOAD UNITS

The sound levels refer to the unit operating at full load and under normal test conditions in cooling mode (outdoor air b.s. (b.u.) temperature = 35 °C (24 °C), inlet-outlet water temperature = 12-7 °C). The tolerance on the total sound power level value is 2 dB(A). The value is determined in accordance with EN 12102-1:2022, used in conjunction with EN ISO 9614-1:2009, which describes the test methods and techniques for measuring sound power using the intensimetric method. Sound pressure values are calculated from the sound power level using UNI EN ISO 3744:2010, considering units operating in the open field.

Model i-290	Octave band sound power level [dB(A)]							Sound power level Lw(A) [dB(A)]	Sound pressure level at 1m [dB(A)]	Sound pressure level at 10m [dB(A)]
	63 Hz	125 Hz	250 Hz	500 Hz	1000 Hz	2000 Hz	4000 Hz			
0106	49,0	48,8	55,6	59,9	61,4	57,0	57,9	66	51,4	34,7
0109	40,1	51,8	53,6	59,2	59,8	56,4	61,4	66	51,4	34,7
0112	46,7	54,7	59,9	64,8	67,1	63,3	59,9	71	55,6	39,6
0115	48,0	52,3	59,8	64,7	68,6	64,5	62,1	72	56,6	40,6
0118	47,4	58,6	60,0	64,9	70,2	64,0	63,4	73	57,6	41,6

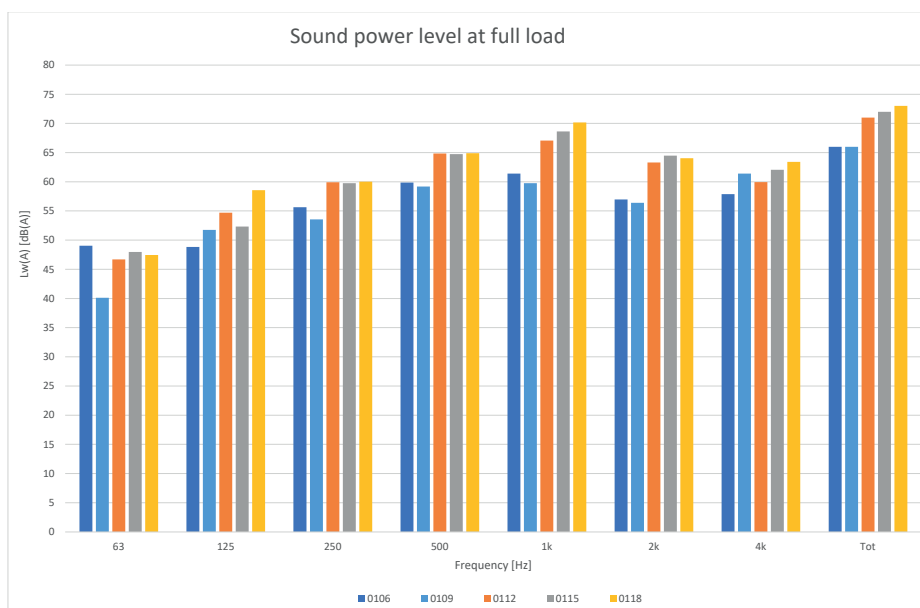

7.2 PARTIAL LOAD UNITS

The sound levels are referred to units at full load operating under conditions that guarantee a thermal capacity equal to that declared at a temperature of 7°C for average climate, in accordance with EN 14825:2022. The tolerance on the value of the total sound power level is 2 dB (A). The value is calculated according with EN 12102-1:2022 regulation used in conjunction with UNI EN ISO 9614-1:2009 which describes the test methods and sound power measurement techniques with the intensimetric method.

The sound pressure values are calculated from the sound power level using UNI EN ISO 3744: 2010, considering units operating in the open field.

Model i-290	Octave band sound power level [dB(A)]							Sound power level Lw(A) [dB(A)]	Sound pressure level at 1m [dB(A)]	Sound pressure level at 10m [dB(A)]
	63 Hz	125 Hz	250 Hz	500 Hz	1000 Hz	2000 Hz	4000 Hz			
0106	48,4	51,2	50,3	50,2	46,7	40,5	44,8	57	42,4	25,7
0109	31,9	38,1	47,5	56,0	50,9	44,7	42,3	58	43,4	26,7
0112	37,9	42,4	48,4	55,1	54,4	47,1	47,0	59	43,6	27,6
0115	42,1	44,2	46,7	50,4	58,6	57,4	50,9	62	46,6	30,6
0118	42,1	44,2	46,7	50,4	58,6	57,4	50,9	62	46,6	30,6

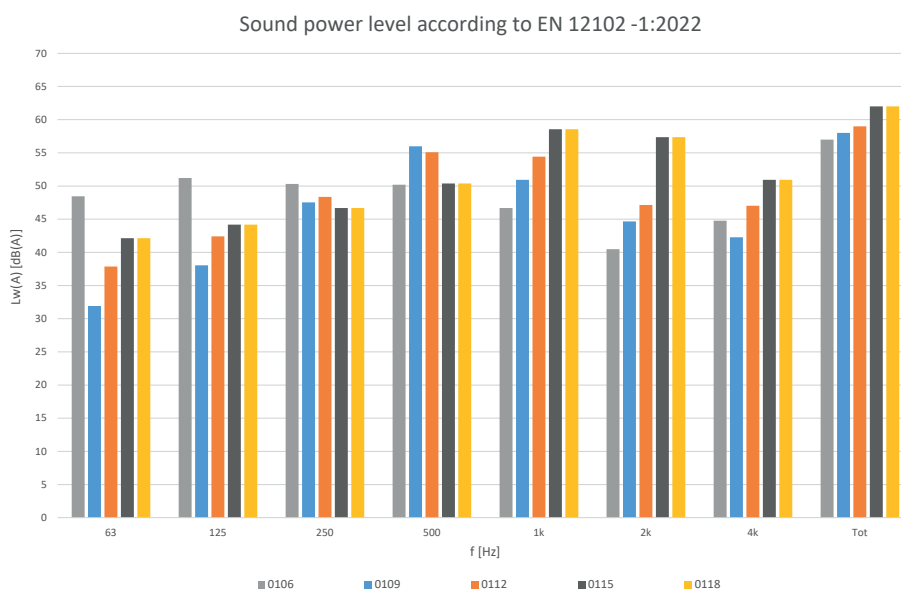

8. OPERATING LIMITS

8.1 EVAPORATOR WATER FLOW

The nominal water flow rate refers to a 5°C temperature difference between the evaporator inlet and outlet. The maximum permitted flow rate features a 3°C temperature difference while the minimum one has an 8°C (in cooling mode) temperature difference at the nominal conditions as shown in the technical sheet. The maximum permissible temperature difference, however, is 10 °C when the heat pump is operating in heating mode.

Insufficient water flow rates can cause excessively low evaporation temperatures causing the safety devices to trigger and stopping the unit and, in some extreme cases, forming ice in the evaporator and resulting in serious failures to the cooling circuit.

For greater details, we have attached a table below with the minimum flow rates for the plate heat exchanger to guarantee proper operation according to the model (please note: the water flowmeter is applied to protect against failed triggering of the antifreeze probe due to the lack of flow but does not guarantee the minimum water flow rate required for correct operation of the unit).

Model i-290	Chiller mode				
	0106	0109	0112	0115	0118
Minimum water flow to be assured in chiller mode (condition (1) technical sheet) [l/s]	0,16	0,26	0,32	0,37	0,41
Maximum water flow to be assured in chiller mode (condition (1) technical sheet) [l/s]	0,43	0,68	0,85	0,99	1,09
Flowmeter intervention rate – decreasing / increasing flow* [l/s]	0,100	0,133	0,167	0,200	0,250



Pay attention to the pressure levels of the hydraulic system: too low values can cause malfunctions of the unit.

For very low hydraulic system pressure values, the flowmeter may show an unstable reading, so it is recommended to have an automatic loading system or a pressure monitoring system.

It is periodically check the state of the deaerator, especially if very high temperature differences are read between the inlet and outlet on the water side, as the presence of air bubbles in the circuit reduces the available water flow rate, altering the flowmeter reading.

As an approximation, and without any other measurement systems, the correct flow rate to guarantee the best performance of the unit can be verified with the circulator at maximum speed, by looking at the pressure gauges to check the pressure difference between the return and discharge water on the external plumbing fittings of the unit and making sure that this reading is equal to or lower than the useful head indicated on the curves shown in Paragraph 6.2 for the respective models.

8.2 COLD WATER PRODUCTION (SUMMER MODE)

A minimum temperature of 5°C is allowed at the evaporator outlet: for lower temperatures, contact the Technical Department. In this case, contact our technical department for a feasibility study and evaluation of the modifications to be made according to the requirements. A maximum temperature of 20°C can be maintained at the evaporator outlet in steady-state operation. Slightly higher temperatures can however be tolerated during transients and in the phases of operation.

8.3 HOT WATER PRODUCTION (WINTER MODE)

When the system has reached steady state, the water outlet temperature must not drop below 22°C: lower values, not due to transient phases or reaching steady-state, can cause system failures and could possibly break the compressor. The maximum outlet water temperature must not exceed 75°C.

There could be failures to the regular operation of the unit or, in more critical cases, the safety devices could be triggered due to temperatures higher than those indicated, especially if coupled with reduced water flow rates.

8.4 AMBIENT AIR TEMPERATURE AND SUMMARY TABLE

The units are designed and built to operate in summer mode, with condensation control, at outdoor air temperatures between 10°C and 46°C. In heat pump mode, the allowed temperature range of the outdoor air goes from -20°C to +20°C depending on the outlet water temperature as shown in the table below.

Water chiller mode		
Air source temperature	Minimum +10°C	Maximum +46°C
Outlet water temperature	Minimum +5°C	Maximum +20°C
Heat pump mode		
Air source temperature	Minimum -20°C	Maximum +20°C
Outlet water temperature	Minimum +22°C	Maximum +75°C
Heat pump mode for domestic hot water		
Air source temperature with water at maximum 39°C	Minimum -20°C	Maximum +43°C
Air source temperature with water at maximum 55°C	Minimum -20°C	Maximum +43°C
Outlet water temperature	Minimum +22°C	Maximum +75°C

Below are the graphed operating limits for heating, cooling and domestic hot water production. Please note that operating the unit outside the stated operating limits causes blocking alarms that lead to product shutdown, with possible damage to components and/or safety organs.

8.5 ENVELOPE IN HEATING AND COOLING

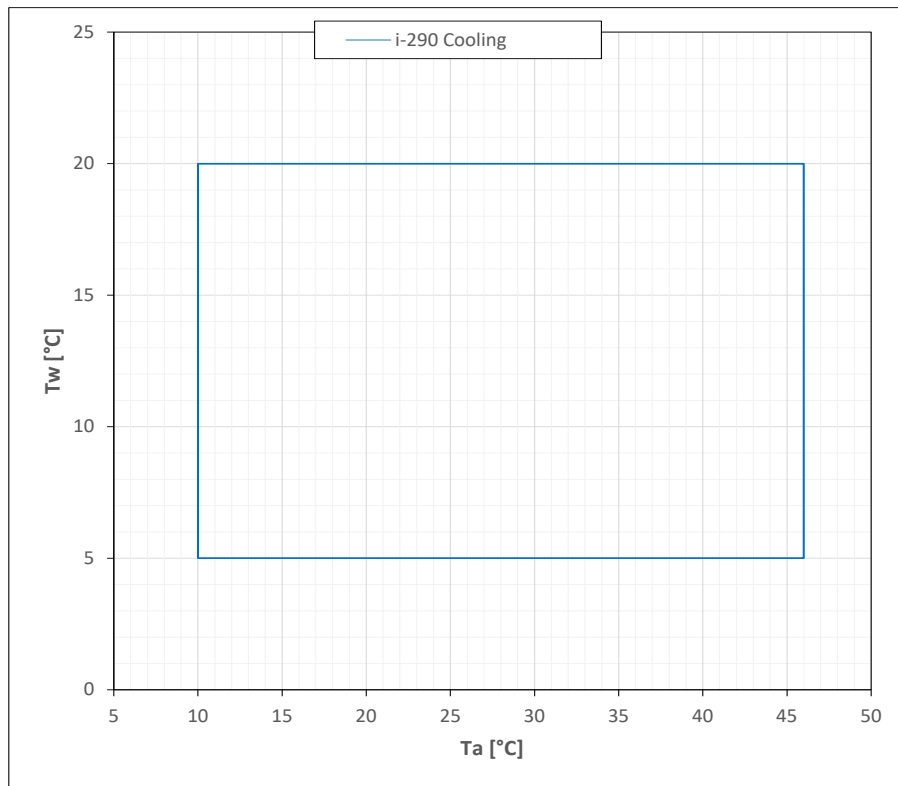
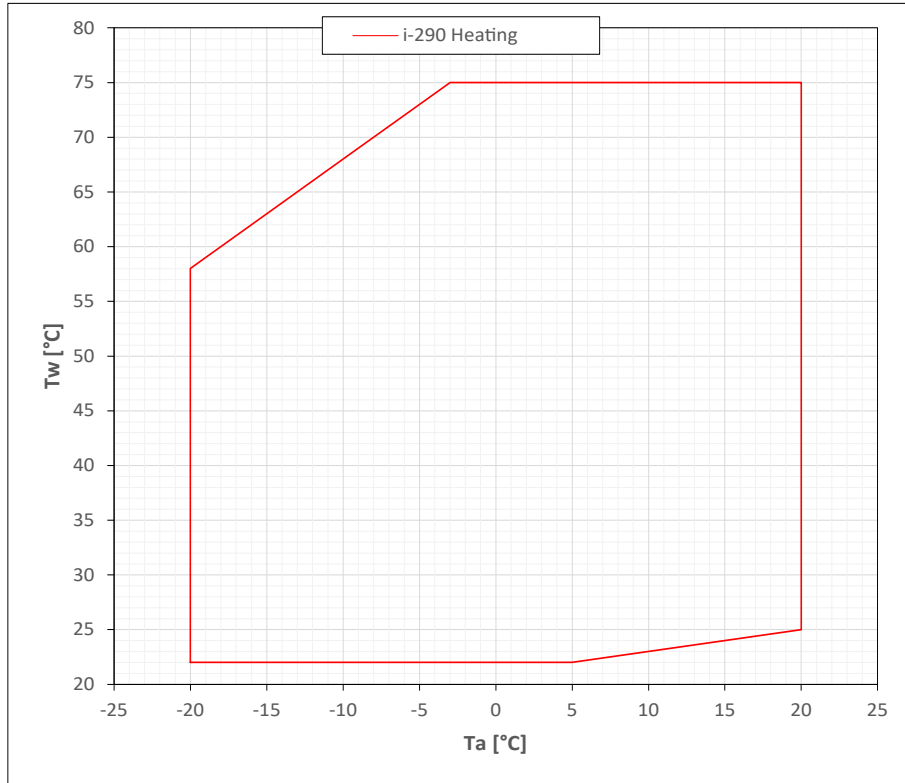

8.6 ENVELOPE IN DHW

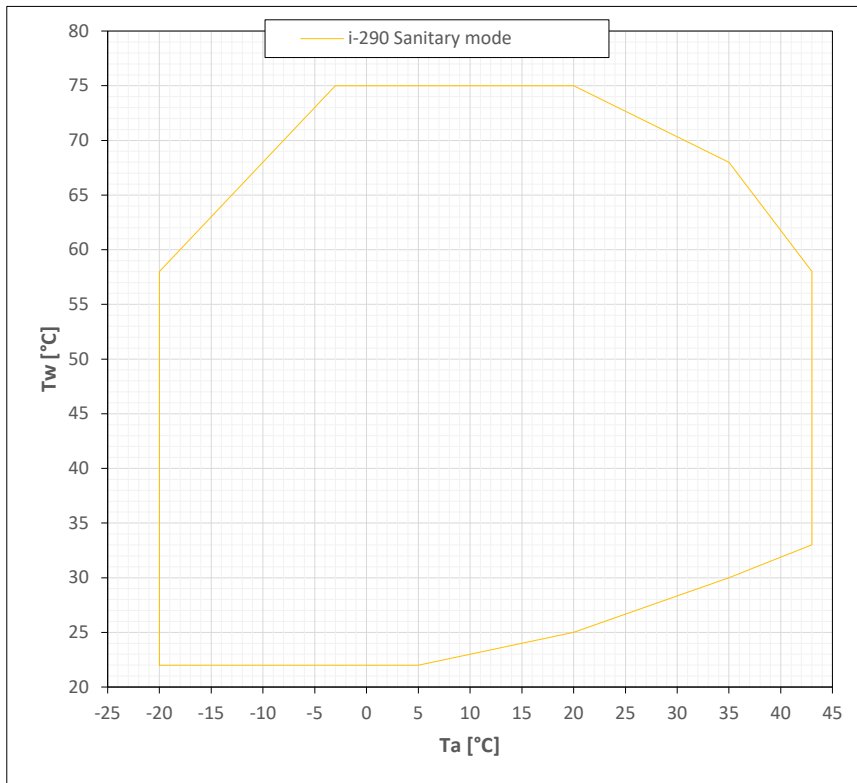

9. PERFORMANCE TABLES

The tables show the capacity, power input and efficiency values for different outside air temperatures. The data shown are calculated according to EN 14511:2022. They are indicative and may be subject to change. (*) Data obtained for a water temperature variation of 5°C.

9.1 HEATING

		HEATING																	
Model i-290	T air outdoor [°C]	Tout [°C]																	
		25			30			35			40			45			50		
		Heating capacity [kW]	Power input [kW]	COP [W/W]	Heating capacity [kW]	Power input [kW]	COP [W/W]	Heating capacity [kW]	Power input [kW]	COP [W/W]	Heating capacity [kW]	Power input [kW]	COP [W/W]	Heating capacity [kW]	Power input [kW]	COP [W/W]	Heating capacity [kW]	Power input [kW]	COP [W/W]
0106	-20	3,42	1,58	2,16	3,34	1,73	1,93	3,24	1,89	1,71	3,15	2,00	1,58	3,10	2,00	1,55	3,01	2,15	1,40
	-15	3,95	1,55	2,55	3,86	1,70	2,27	3,77	1,85	2,04	3,69	1,95	1,89	3,66	1,98	1,85	3,59	2,12	1,69
	-10	4,30	1,39	3,09	4,23	1,53	2,77	4,16	1,67	2,49	4,07	1,82	2,24	4,08	1,84	2,21	4,00	1,98	2,02
	-7	4,66	1,33	3,50	4,58	1,47	3,12	4,50	1,61	2,81	4,41	1,75	2,52	4,41	1,80	2,45	4,33	1,93	2,24
	-2	5,04	1,25	4,03	4,95	1,38	3,59	4,86	1,52	3,20	4,76	1,66	2,87	4,74	1,75	2,71	4,64	1,88	2,47
	2	6,11	1,23	4,98	5,92	1,34	4,41	5,87	1,50	3,91	5,77	1,65	3,50	5,74	1,77	3,24	5,62	1,92	2,93
	7	6,60	1,07	6,15	6,37	1,17	5,44	6,24	1,31	4,76	6,12	1,45	4,22	6,05	1,62	3,74	5,90	1,77	3,33
	12	6,69	0,86	7,77	6,53	1,01	6,47	6,39	1,15	5,56	6,26	1,29	4,85	6,22	1,42	4,38	6,06	1,57	3,86
	15	6,71	0,83	8,08	6,58	0,97	6,78	6,42	1,12	5,73	6,33	1,27	4,98	6,28	1,37	4,58	6,15	1,52	4,05
	20	6,81	0,76	8,96	6,70	0,90	7,44	6,58	1,05	6,27	6,45	1,20	5,38	6,48	1,28	5,06	6,36	1,43	4,45
0109	-20	5,77	2,46	2,35	5,66	2,59	2,19	5,56	2,72	2,04	5,45	2,86	1,91	5,22	2,76	1,89	5,12	2,90	1,77
	-15	6,55	2,43	2,70	6,41	2,56	2,50	6,30	2,69	2,34	6,19	2,84	2,18	6,06	2,87	2,12	5,95	3,01	1,98
	-10	7,46	2,39	3,12	7,35	2,52	2,92	7,24	2,67	2,71	7,11	2,82	2,52	7,10	2,99	2,38	7,07	3,16	2,24
	-7	8,19	2,37	3,46	8,06	2,51	3,21	7,93	2,66	2,98	7,81	2,81	2,78	7,85	3,07	2,56	7,73	3,24	2,39
	-2	8,68	2,16	4,02	8,51	2,30	3,70	8,36	2,44	3,43	8,20	2,60	3,15	8,23	2,85	2,89	8,08	3,02	2,68
	2	9,05	1,98	4,57	8,86	2,11	4,20	8,69	2,26	3,85	8,51	2,41	3,53	8,62	2,66	3,24	8,52	2,83	3,01
	7	10,18	1,72	5,90	9,93	1,91	5,20	9,69	2,05	4,72	9,45	2,21	4,28	9,43	2,46	3,84	9,20	2,64	3,48
	12	10,86	1,53	7,17	10,54	1,68	6,25	10,25	1,84	5,60	9,97	1,98	5,04	9,97	2,23	4,47	9,66	2,41	4,01
	15	10,95	1,46	7,47	10,64	1,62	6,54	10,33	1,77	5,82	10,04	1,92	5,21	10,08	2,17	4,65	9,76	2,35	4,15
	20	11,06	1,33	8,35	10,77	1,48	7,30	10,43	1,64	6,34	10,13	1,79	5,64	10,19	2,05	4,98	9,79	2,23	4,39
0112	-20	7,49	3,21	2,33	7,33	3,31	2,21	7,18	3,44	2,09	7,08	3,60	1,97	6,94	3,88	1,79	6,83	4,09	1,67
	-15	7,95	3,11	2,56	7,82	3,22	2,43	7,70	3,37	2,29	7,65	3,54	2,16	7,50	3,83	1,96	7,36	4,04	1,82
	-10	8,34	2,83	2,95	8,21	2,96	2,77	8,11	3,12	2,60	8,02	3,30	2,44	7,88	3,59	2,20	7,80	3,79	2,06
	-7	8,76	2,71	3,23	8,65	2,84	3,05	8,52	3,01	2,84	8,42	3,19	2,65	8,27	3,48	2,38	8,18	3,69	2,22
	-2	9,76	2,53	3,86	9,64	2,69	3,58	9,49	2,87	3,31	9,36	3,06	3,06	9,15	3,34	2,74	9,02	3,55	2,54
	2	11,97	2,57	4,65	11,79	2,72	4,33	11,63	2,95	3,93	11,48	3,16	3,64	11,20	3,46	3,24	11,03	3,69	2,98
	7	13,14	2,15	6,11	12,78	2,40	5,33	12,60	2,61	4,83	12,36	2,83	4,38	11,99	3,10	3,86	11,78	3,34	3,53
	12	14,03	1,86	7,53	13,80	2,07	6,67	13,57	2,28	5,97	13,32	2,50	5,32	12,93	2,77	4,66	12,68	3,01	4,22
	15	14,27	1,76	8,13	14,05	1,96	7,19	13,83	2,17	6,36	13,59	2,39	5,69	13,22	2,66	4,98	12,97	2,89	4,50
	20	14,77	1,55	9,55	14,57	1,75	8,34	14,35	1,96	7,30	14,11	2,18	6,47	13,91	2,43	5,72	13,66	2,66	5,15
0115	-20	9,77	4,13	2,37	9,79	4,33	2,26	9,75	4,54	2,15	9,65	4,77	2,02	9,46	5,24	1,81	9,34	5,51	1,70
	-15	10,82	4,09	2,64	10,78	4,32	2,50	10,73	4,55	2,35	10,63	4,80	2,21	10,39	5,15	2,02	10,27	5,44	1,89
	-10	12,18	3,98	3,07	12,06	4,22	2,87	12,00	4,47	2,69	11,90	4,74	2,51	11,66	4,98	2,35	11,50	5,27	2,18
	-7	13,14	3,93	3,33	13,03	4,19	3,11	12,94	4,44	2,91	12,82	4,72	2,71	12,56	4,89	2,58	12,41	5,19	2,39
	-2	13,79	3,50	3,94	13,60	3,76	3,62	13,45	4,02	3,33	13,28	4,29	3,10	13,01	4,51	2,88	12,81	4,80	2,67
	2	16,46	3,31	4,97	16,17	3,58	4,53	15,94	3,86	4,12	15,71	4,14	3,79	15,44	4,43	3,48	15,18	4,73	3,21
	7	16,82	2,76	6,09	16,67	3,03	5,51	16,33	3,30	4,94	16,06	3,59	4,49	15,84	3,91	4,05	15,55	4,21	3,68
	12	17,72	2,38	7,47	17,33	2,65	6,53	16,97	2,94	5,78	16,62	3,24	5,12	16,44	3,54	4,63	16,12	3,85	4,18
	15	17,75	2,30	7,74	17,34	2,58	6,71	16,98	2,87	5,92	16,65	3,18	5,27	16,54	3,46	4,77	16,24	3,77	4,30
	20	18,10	2,11	8,58	17,71	2,40	7,38	17,40	2,70	6,44	17,11	3,01	5,68	17,10	3,28	5,21	16,80	3,60	4,67
0118	-20	8,81	4,02	2,19	8,82	4,20	2,10	8,80	4,40	2,00	8,73	4,62	1,89	8,80	4,86	1,81	8,68	5,11	1,70
	-15	9,82	3,91	2,51	9,81	4,12	2,38	9,76	4,34	2,25	9,67	4,57	2,12	9,70	4,84	2,00	9,59	5,11	1,88
	-10	11,47	3,88	2,96	11,45	4,12	2,77	11,39	4,36	2,62	11,31	4,62	2,45	11,34	4,93	2,29	11,19	5,22	2,15
	-7	12,72	3,87	3,28	12,66	4,12	3,08	12,56	4,38	2,88	12,46	4,65	2,69	12,46	4,99	2,51	12,32	5,29	2,33
	-2	14,14	3,82	3,69	14,03	4,10	3,42	13,86	4,39	3,17	13,70	4,68	2,93	13,61	5,02	2,71	13,42	5,34	2,51
	2	18,28	3,94	4,64	18,09	4,26	4,26	17,88	4,57	3,92	17,61	4,90	3,59	17,42	5,25	3,31	17,16	5,61	3,07
	7	19,09	3,42	5,59	19,00	3,73	5,09	18,72	4,05	4,62	18,40	4,38	4,20	18,10	4,71	3,84	17,78	5,06	3,52
	12	20,34	3,01	6,74	19,98	3,33	6,01	19,62	3,67	5,34	19,30	4,02	4,80	19,15	4,32	4,44	18,81	4,68	4,02
	15	20,28	2,88	7,05	19,88	3,21	6,20	19,49	3,55	5,49	19,16	3,90	4,92	19,26	4,19	4,61	18,88	4,55	4,15
	20	20,38	2,61	7,82	19,98	2,94	6,80	19,66	3,29	5,99	19,37	3,64	5,33	19,71	3,91	5,04	19,40	4,28	4,53

HEATING																
Model i-290	T air outdoor [°C]	Tout [°C]														
		55 (*)			60 (*)			65 (*)			70 (*)			75 (*)		
		Heating capacity [kW]	Power input [kW]	COP [W/W]	Heating capacity [kW]	Power input [kW]	COP [W/W]	Heating capacity [kW]	Power input [kW]	COP [W/W]	Heating capacity [kW]	Power input [kW]	COP [W/W]	Heating capacity [kW]	Power input [kW]	COP [W/W]
0106	-20	2,89	2,29	1,26	-	-	-	-	-	-	-	-	-	-	-	-
	-15	3,47	2,26	1,54	3,53	2,46	1,44	-	-	-	-	-	-	-	-	-
	-10	3,91	2,12	1,84	3,94	2,33	1,69	3,85	2,48	1,55	-	-	-	-	-	-
	-7	4,23	2,07	2,04	4,30	2,30	1,87	4,20	2,45	1,71	4,11	2,60	1,58	-	-	-
	-2	4,54	2,02	2,25	4,58	2,24	2,05	4,48	2,39	1,88	4,36	2,53	1,72	4,26	2,69	1,59
	2	5,51	2,07	2,66	5,54	2,29	2,42	5,42	2,45	2,21	5,28	2,61	2,02	5,14	2,78	1,85
	7	5,77	1,92	3,01	5,90	2,17	2,72	5,75	2,33	2,46	5,61	2,49	2,25	5,45	2,66	2,05
	12	5,92	1,72	3,44	5,84	1,90	3,07	5,68	2,05	2,77	5,54	2,21	2,51	5,39	2,38	2,26
	15	6,00	1,67	3,59	5,92	1,85	3,20	5,76	2,01	2,88	5,62	2,17	2,60	5,47	2,33	2,35
	20	6,22	1,58	3,94	6,17	1,76	3,51	6,04	1,92	3,15	5,90	2,09	2,82	5,77	2,26	2,55
0109	-20	5,03	3,04	1,65	-	-	-	-	-	-	-	-	-	-	-	-
	-15	5,84	3,17	1,84	6,06	3,57	1,70	-	-	-	-	-	-	-	-	-
	-10	6,91	3,33	2,08	7,26	3,87	1,88	7,13	4,06	1,76	-	-	-	-	-	-
	-7	7,62	3,42	2,23	8,06	4,05	1,99	7,94	4,27	1,86	7,82	4,49	1,74	-	-	-
	-2	7,93	3,21	2,47	8,14	3,67	2,22	8,00	3,89	2,06	7,83	4,12	1,90	7,68	4,36	1,76
	2	8,40	3,02	2,78	8,46	3,34	2,53	8,33	3,56	2,34	8,23	3,80	2,17	8,14	4,11	1,98
	7	8,96	2,83	3,17	9,20	3,27	2,81	8,94	3,50	2,56	8,69	3,74	2,32	8,44	3,99	2,12
	12	9,38	2,61	3,61	9,78	3,10	3,16	9,48	3,33	2,85	9,19	3,57	2,57	8,87	3,83	2,32
	15	9,46	2,54	3,72	9,83	3,00	3,28	9,54	3,23	2,95	9,20	3,47	2,65	8,89	3,73	2,38
	20	9,51	2,42	3,93	9,89	2,83	3,50	9,61	3,05	3,15	9,30	3,29	2,83	9,01	3,55	2,54
0112	-20	6,72	4,31	1,56	-	-	-	-	-	-	-	-	-	-	-	-
	-15	7,24	4,25	1,70	7,37	4,80	1,54	-	-	-	-	-	-	-	-	-
	-10	7,70	4,01	1,92	7,83	4,53	1,73	7,70	4,75	1,62	-	-	-	-	-	-
	-7	8,06	3,90	2,07	8,26	4,42	1,87	8,07	4,64	1,74	7,90	4,85	1,63	-	-	-
	-2	8,86	3,77	2,35	9,11	4,38	2,08	8,94	4,60	1,94	8,72	4,81	1,81	8,49	5,02	1,69
	2	10,83	3,93	2,75	11,21	4,67	2,40	11,00	4,92	2,24	10,75	5,16	2,09	10,47	5,38	1,95
	7	11,55	3,57	3,25	12,13	4,40	2,75	11,90	4,66	2,55	11,63	4,91	2,37	11,38	5,14	2,22
	12	12,44	3,25	3,82	13,18	4,03	3,28	12,91	4,29	3,01	12,66	4,54	2,80	12,40	4,78	2,59
	15	12,64	3,12	4,04	13,43	3,85	3,48	13,17	4,11	3,21	12,91	4,36	2,96	12,69	4,60	2,76
	20	13,44	2,90	4,62	14,09	3,52	4,01	13,84	3,78	3,65	13,68	4,04	3,39	13,50	4,28	3,15
0115	-20	9,21	5,82	1,58	-	-	-	-	-	-	-	-	-	-	-	-
	-15	10,15	5,75	1,77	9,88	6,23	1,59	-	-	-	-	-	-	-	-	-
	-10	11,37	5,58	2,04	11,18	6,02	1,86	10,98	6,38	1,72	-	-	-	-	-	-
	-7	12,22	5,49	2,22	12,03	5,92	2,03	11,87	6,28	1,90	11,70	6,66	1,76	-	-	-
	-2	12,59	5,10	2,47	12,41	5,55	2,23	12,17	5,89	2,07	11,93	6,24	1,91	11,66	6,62	1,77
	2	14,91	5,04	2,96	14,74	5,55	2,65	14,42	5,89	2,45	14,05	6,25	2,24	13,63	6,62	2,05
	7	15,24	4,52	3,36	14,85	4,92	3,03	14,46	5,25	2,76	13,98	5,58	2,51	13,42	5,91	2,27
	12	15,77	4,16	3,80	15,38	4,62	3,33	14,92	4,96	3,00	14,35	5,29	2,70	13,71	5,63	2,43
	15	15,87	4,09	3,89	15,52	4,59	3,38	15,04	4,93	3,04	14,46	5,27	2,75	13,88	5,62	2,47
	20	16,46	3,94	4,19	16,20	4,50	3,60	15,75	4,86	3,25	15,21	5,22	2,91	14,57	5,59	2,61
0118	-20	8,55	5,39	1,59	-	-	-	-	-	-	-	-	-	-	-	-
	-15	9,47	5,40	1,75	9,74	5,96	1,63	-	-	-	-	-	-	-	-	-
	-10	11,05	5,53	2,01	11,31	6,09	1,86	11,17	6,46	1,73	-	-	-	-	-	-
	-7	12,14	5,61	2,16	12,45	6,18	2,02	12,23	6,55	1,86	12,06	6,96	1,74	-	-	-
	-2	13,21	5,68	2,32	13,31	6,25	2,13	13,07	6,64	1,98	12,85	7,05	1,83	12,62	7,49	1,68
	2	16,87	5,97	2,83	16,87	6,55	2,58	16,53	6,96	2,37	16,20	7,39	2,19	15,87	7,84	2,03
	7	17,47	5,42	3,23	16,89	5,78	2,92	16,46	6,16	2,68	16,03	6,55	2,44	15,56	6,95	2,25
	12	18,43	5,05	3,64	17,69	5,45	3,25	17,19	5,83	2,95	16,66	6,22	2,69	16,07	6,61	2,44
	15	18,48	4,91	3,77	17,70	5,32	3,33	17,26	5,71	3,03	16,68	6,10	2,74	16,06	6,49	2,48
	20	19,03	4,65	4,09	18,19	5,09	3,58	17,73	5,48	3,23	17,22	5,88	2,93	16,63	6,28	2,64

9.2 COOLING

Model i-290		COOLING																		
		T air outdoor [°C]	Tout [°C]																	
			5			7			10			12			15			18		
Cooling capacity [kW]	Power input [kW]	EER [W/W]	Cooling capacity [kW]	Power input [kW]	EER [W/W]	Cooling capacity [kW]	Power input [kW]	EER [W/W]	Cooling capacity [kW]	Power input [kW]	EER [W/W]	Cooling capacity [kW]	Power input [kW]	EER [W/W]	Cooling capacity [kW]	Power input [kW]	EER [W/W]			
0106	20	5,57	1,21	4,60	5,88	1,22	4,82	6,41	1,23	5,21	5,69	0,93	6,09	15,56	0,74	7,51	6,01	0,73	8,25	
	25	5,41	1,43	3,78	5,73	1,44	3,98	6,29	1,46	4,31	5,64	1,11	5,06	15,45	0,92	5,92	5,95	0,91	6,54	
	30	5,33	1,70	3,14	5,68	1,69	3,36	6,16	1,75	3,52	5,54	1,31	4,22	15,38	1,08	4,98	5,81	1,09	5,33	
	35	5,14	1,92	2,68	5,43	1,95	2,79	5,88	2,00	2,94	5,36	1,51	3,55	15,12	1,26	4,06	5,62	1,26	4,50	
	40	5,03	2,16	2,33	5,30	2,19	2,42	5,83	2,24	2,60	5,23	1,71	3,05	14,99	1,45	3,44	5,46	1,46	3,74	
	45	4,72	2,32	2,03	5,00	2,35	2,13	5,46	2,39	2,29	4,84	1,85	2,62	14,64	1,57	2,96	5,11	1,60	3,19	
0109	20	8,14	1,80	4,52	8,82	1,82	4,83	9,70	1,85	5,24	8,72	1,48	5,91	18,32	1,15	7,24	8,97	1,14	7,88	
	25	8,18	2,07	3,95	8,86	2,09	4,24	9,63	2,13	4,52	8,92	1,76	5,06	18,36	1,37	6,10	9,17	1,37	6,69	
	30	8,27	2,42	3,42	8,79	2,45	3,59	9,58	2,49	3,85	9,16	2,12	4,32	18,57	1,65	5,19	9,38	1,65	5,69	
	35	8,15	2,75	2,96	8,57	2,77	3,09	9,55	2,83	3,38	9,12	2,47	3,69	18,41	1,91	4,40	9,15	1,93	4,75	
	40	7,73	3,11	2,48	8,26	3,18	2,60	9,03	3,26	2,77	8,92	2,86	3,12	18,37	2,27	3,69	9,08	2,31	3,93	
	45	7,03	3,35	2,10	7,41	3,40	2,18	8,13	3,48	2,34	8,11	3,07	2,64	17,73	2,48	3,12	8,52	2,53	3,37	
0112	20	10,36	2,20	4,70	11,19	2,24	4,99	12,29	2,20	5,58	11,41	1,90	5,99	21,20	1,65	6,79	12,26	1,61	7,64	
	25	10,42	2,64	3,94	11,29	2,67	4,23	12,28	2,70	4,56	11,49	2,33	4,94	21,44	2,09	5,46	12,66	2,06	6,15	
	30	10,28	3,21	3,21	11,04	3,20	3,44	12,10	3,26	3,71	11,45	2,79	4,10	21,48	2,45	4,69	12,67	2,48	5,10	
	35	9,80	3,72	2,63	10,67	3,75	2,85	11,65	3,79	3,09	11,13	3,24	3,43	21,36	2,88	3,96	12,57	2,83	4,44	
	40	9,54	4,32	2,21	10,10	4,39	2,30	11,18	4,47	2,51	10,88	3,83	2,84	21,24	3,40	3,29	12,36	3,44	3,60	
	45	8,78	4,64	1,89	9,29	4,70	1,98	10,19	4,82	2,12	9,99	4,17	2,40	20,45	3,68	2,83	11,34	3,76	3,02	
0115	20	10,56	1,84	5,76	11,34	1,82	6,21	12,63	1,77	7,12	11,18	1,48	7,57	21,98	1,08	9,24	10,94	1,02	10,73	
	25	11,47	2,44	4,71	12,41	2,44	5,08	13,72	2,40	5,71	12,23	2,03	6,02	21,18	1,50	7,47	12,19	1,46	8,36	
	30	11,75	3,09	3,82	12,78	3,07	4,17	13,82	3,10	4,45	12,78	2,60	4,91	21,67	1,97	5,94	12,76	1,94	6,63	
	35	11,60	3,71	3,13	12,41	3,71	3,35	13,63	3,76	3,62	12,80	3,15	4,06	21,84	2,43	4,88	12,90	2,40	5,37	
	40	11,32	4,31	2,62	12,18	4,33	2,82	13,40	4,42	3,03	12,61	3,79	3,32	21,77	3,00	3,93	12,95	3,00	4,33	
	45	10,39	4,64	2,24	11,04	4,71	2,34	12,34	4,77	2,58	11,45	4,14	2,76	20,94	3,31	3,29	11,91	3,33	3,57	
0118	20	12,08	2,26	5,35	12,87	2,24	5,75	14,14	2,22	6,35	12,70	1,83	6,93	21,71	1,41	8,30	12,61	1,37	9,22	
	25	12,66	2,96	4,29	13,56	2,94	4,63	15,11	2,94	5,14	13,45	2,37	5,66	22,10	1,76	6,88	13,05	1,73	7,51	
	30	13,01	3,64	3,57	14,06	3,68	3,83	15,52	3,67	4,24	13,99	2,98	4,69	22,58	2,25	5,63	13,75	2,22	6,17	
	35	12,94	4,35	2,97	13,75	4,34	3,16	15,18	4,43	3,43	14,02	3,59	3,91	22,89	2,71	4,76	13,94	2,69	5,18	
	40	12,81	5,02	2,55	13,47	5,05	2,67	14,92	5,12	2,91	13,66	4,25	3,21	22,77	3,33	3,84	13,84	3,33	4,16	
	45	11,83	5,43	2,17	12,43	5,46	2,27	13,68	5,55	2,47	12,59	4,64	2,72	21,64	3,65	3,18	12,64	3,69	3,43	

9.3 SANITARY

The tables show the heating capacity, input power and COP values at various outdoor air temperatures during summer for technical water at 45 / 50 / 55 / 60 / 65 / 70 / 75 °C for domestic hot water production. The technical data are indicative and are subject to change.
 (*) Data obtained for a water temperature variation of 5°C.

HEATING																						
Model i-290	T air outdoor [°C]	Tout [°C]																				
		45			50			55 (*)			60 (*)			65 (*)			70 (*)			75 (*)		
		Heating capacity [kW]	Power input [kW]	COP [W/W]	Heating capacity [kW]	Power input [kW]	COP [W/W]	Heating capacity [kW]	Power input [kW]	COP [W/W]	Heating capacity [kW]	Power input [kW]	COP [W/W]	Heating capacity [kW]	Power input [kW]	COP [W/W]	Heating capacity [kW]	Power input [kW]	COP [W/W]	Heating capacity [kW]	Power input [kW]	COP [W/W]
0106	20	6,48	1,28	5,06	6,36	1,43	4,45	6,22	1,58	3,94	6,17	1,76	3,51	6,04	1,92	3,15	5,90	2,09	2,82	5,77	2,26	2,55
	25	6,53	1,14	5,73	6,40	1,29	4,96	6,26	1,44	4,35	6,23	1,62	3,85	6,09	1,78	3,42	5,96	1,95	3,06	-	-	-
	30	7,17	1,12	6,41	6,95	1,27	5,47	6,82	1,43	4,77	6,78	1,62	4,19	6,64	1,80	3,69	6,52	1,97	3,31	-	-	-
	35	7,59	1,10	6,90	7,45	1,26	5,91	7,28	1,42	5,13	7,24	1,62	4,47	7,02	1,79	3,92	-	-	-	-	-	-
	40	7,89	1,09	7,24	7,68	1,25	6,14	7,47	1,41	5,30	7,40	1,61	4,60	-	-	-	-	-	-	-	-	-
0109	20	10,19	2,05	4,98	9,79	2,23	4,39	9,51	2,42	3,93	9,89	2,83	3,50	9,61	3,05	3,15	9,30	3,29	2,83	9,01	3,55	2,54
	25	10,30	1,80	5,72	9,89	1,98	4,99	9,61	2,23	4,31	9,77	2,56	3,82	9,40	2,77	3,39	9,05	2,99	3,03	-	-	-
	30	11,10	1,81	6,13	10,70	1,99	5,38	10,44	2,25	4,64	10,60	2,59	4,09	10,20	2,80	3,64	9,73	3,02	3,22	-	-	-
	35	11,90	1,81	6,57	11,50	2,00	5,75	11,23	2,27	4,94	11,40	2,61	4,37	11,00	2,84	3,87	-	-	-	-	-	-
	40	13,10	1,80	7,28	12,70	2,01	6,32	12,41	2,30	5,40	12,51	2,66	4,70	-	-	-	-	-	-	-	-	-
0112	20	13,91	2,43	5,72	13,66	2,66	5,15	13,44	2,90	4,62	14,09	3,52	4,01	13,84	3,78	3,65	13,68	4,04	3,39	-	4,28	3,15
	25	14,30	2,11	6,78	14,10	2,33	6,05	14,40	2,71	5,31	14,80	3,20	4,62	14,60	3,46	4,22	14,30	3,72	3,84	-	-	-
	30	15,92	2,05	7,75	15,60	2,28	6,84	15,90	2,67	5,96	16,50	3,15	5,24	16,10	3,41	4,72	15,90	3,67	4,33	-	-	-
	35	17,40	2,00	8,70	17,00	2,24	7,59	17,40	2,64	6,59	18,10	3,09	5,86	17,80	3,36	5,30	-	-	-	-	-	-
	40	18,40	1,95	9,44	17,90	2,19	8,17	18,40	2,59	7,10	19,10	3,01	6,35	-	-	-	-	-	-	-	-	-
0115	20	17,10	3,28	5,21	16,80	3,60	4,67	16,46	3,94	4,19	16,20	4,50	3,60	15,75	4,86	3,25	15,21	5,22	2,91	-	5,59	2,61
	25	17,10	2,93	5,84	16,80	3,26	5,15	16,50	3,59	4,60	16,30	4,19	3,89	15,80	4,55	3,47	15,30	4,92	3,11	-	-	-
	30	18,00	2,92	6,16	17,60	3,27	5,38	17,10	3,62	4,72	16,90	4,28	3,95	16,30	4,66	3,50	15,60	5,03	3,10	-	-	-
	35	18,00	2,94	6,12	17,60	3,29	5,35	17,20	3,65	4,71	17,00	4,37	3,89	16,50	4,75	3,47	-	-	-	-	-	-
	40	18,10	2,96	6,11	17,70	3,31	5,35	17,30	3,67	4,71	17,20	4,45	3,87	-	-	-	-	-	-	-	-	-
0118	20	19,71	3,91	5,04	19,40	4,28	4,53	19,03	4,65	4,09	18,19	5,09	3,58	17,73	5,48	3,23	17,22	5,88	2,93	-	6,28	2,64
	25	19,60	3,46	5,66	19,20	3,82	5,03	18,70	4,19	4,46	17,70	4,63	3,82	17,10	5,00	3,42	16,40	5,37	3,05	-	-	-
	30	19,90	3,48	5,72	19,40	3,85	5,04	18,90	4,21	4,49	17,90	4,68	3,82	17,30	5,06	3,42	16,60	5,44	3,05	-	-	-
	35	20,10	3,49	5,76	19,60	3,87	5,06	19,20	4,24	4,53	18,10	4,73	3,83	17,50	5,12	3,42	-	-	-	-	-	-
	40	20,30	3,51	5,78	19,90	3,89	5,12	19,40	4,26	4,55	18,30	4,78	3,83	-	-	-	-	-	-	-	-	-

9.4 MINIMUM LOAD

The following tables show the values of minimum capacity, power input and efficiency for different outdoor air and water outlet temperatures. The data are useful to understand the minimum capacity of the heat pump and are essential for the correct choice of unit. Failure to meet the minimum load on the heat pump results in intermittent operation with numerous restarts and a reduction in compressor life. The data is obtained with a fixed flow rate (balancing the system at the minimum flow rate guaranteed by the pump partialisation at the set point) and with fixed Tout for 35/45/65 °C (in heating) and 7/18 °C (in cooling). The heating data also take into account any defrosting.

HEATING - MINIMUM LOAD													
Model i-290	T air outdoor [°C]	Tout [°C]											
		35			45			55			65		
		Heating capacity [kW]	Power input [kW]	COP [W/W]	Heating capacity [kW]	Power input [kW]	COP [W/W]	Heating capacity [kW]	Power input [kW]	COP [W/W]	Heating capacity [kW]	Power input [kW]	COP [W/W]
0106	-20	1,27	0,76	1,68	1,19	0,82	1,44	1,08	0,94	1,15	-	-	-
	-15	1,48	0,76	1,95	1,39	0,83	1,67	1,28	0,95	1,35	-	-	-
	-10	1,79	0,75	2,38	1,69	0,85	1,99	1,57	0,97	1,62	1,51	1,14	1,33
	-7	2,01	0,75	2,69	1,92	0,86	2,23	1,79	0,98	1,82	1,74	1,15	1,51
	-2	2,52	0,73	3,47	2,32	0,86	2,69	2,22	1,00	2,22	2,16	1,18	1,83
	2	2,97	0,70	4,25	2,85	0,86	3,30	2,72	1,01	2,69	2,62	1,19	2,20
	7	3,48	0,64	5,46	3,33	0,83	4,00	3,12	0,99	3,16	3,04	1,19	2,55
	12	3,99	0,60	6,61	3,84	0,80	4,84	3,64	0,98	3,70	3,50	1,19	2,93
	15	4,13	0,60	6,88	4,02	0,78	5,12	3,84	0,97	3,95	3,71	1,20	3,10
0109	20	4,64	0,57	8,14	4,52	0,76	5,99	4,33	0,96	4,52	4,19	1,19	3,53
	-20	1,67	0,93	1,79	1,50	0,99	1,52	1,31	1,06	1,24	-	-	-
	-15	1,92	0,89	2,15	1,76	0,98	1,79	1,54	1,05	1,47	-	-	-
	-10	2,28	0,85	2,67	2,12	0,98	2,15	1,88	1,06	1,78	1,73	1,26	1,37
	-7	2,53	0,82	3,09	2,37	0,97	2,43	2,10	1,05	2,01	1,97	1,28	1,54
	-2	3,03	0,77	3,91	2,82	0,94	3,00	2,54	1,03	2,45	2,33	1,24	1,88
	2	3,73	0,79	4,71	3,49	0,97	3,59	3,17	1,10	2,88	2,88	1,29	2,23
	7	4,31	0,74	5,80	4,06	0,94	4,33	3,65	1,05	3,47	3,39	1,27	2,67
	12	4,99	0,70	7,15	4,73	0,90	5,26	4,21	1,02	4,11	3,98	1,26	3,16
0112	15	5,16	0,68	7,58	4,92	0,89	5,53	4,39	1,02	4,30	4,16	1,26	3,31
	20	5,57	0,65	8,53	5,36	0,87	6,14	4,83	1,02	4,75	4,66	1,26	3,71
	-20	2,43	1,29	1,88	2,17	1,42	1,53	1,93	1,49	1,30	-	-	-
	-15	2,78	1,28	2,16	2,52	1,43	1,76	2,26	1,51	1,49	-	-	-
	-10	3,24	1,27	2,55	2,97	1,44	2,06	2,70	1,54	1,75	2,56	1,79	1,43
	-7	3,55	1,26	2,82	3,28	1,44	2,27	2,98	1,55	1,92	2,83	1,81	1,56
	-2	4,17	1,20	3,47	3,97	1,42	2,80	3,70	1,56	2,37	3,55	1,88	1,89
	2	5,35	1,23	4,34	4,98	1,45	3,43	4,50	1,57	2,86	4,29	1,93	2,23
	7	6,30	1,13	5,57	5,86	1,37	4,28	5,18	1,47	3,52	4,91	1,84	2,67
0115	12	7,39	1,04	7,08	6,90	1,31	5,29	6,17	1,44	4,29	5,88	1,83	3,22
	15	7,76	1,02	7,64	7,31	1,28	5,69	6,55	1,42	4,60	6,37	1,81	3,51
	20	8,83	0,94	9,37	8,42	1,22	6,88	7,70	1,40	5,49	7,42	1,79	4,14
	-20	2,47	1,35	1,83	2,30	1,52	1,51	2,16	1,59	1,36	-	-	-
	-15	2,87	1,37	2,11	2,67	1,52	1,76	2,50	1,59	1,57	-	-	-
	-10	3,46	1,39	2,50	3,24	1,52	2,13	3,02	1,62	1,87	2,76	1,77	1,56
	-7	3,85	1,39	2,77	3,62	1,52	2,38	3,36	1,62	2,08	3,10	1,78	1,74
	-2	4,86	1,38	3,52	4,58	1,56	2,94	4,27	1,69	2,52	3,95	1,90	2,08
	2	5,91	1,37	4,32	5,59	1,59	3,52	5,22	1,75	2,98	4,86	2,01	2,42
0118	7	6,89	1,29	5,34	6,56	1,56	4,20	6,20	1,79	3,47	5,78	2,08	2,79
	12	7,87	1,24	6,33	7,54	1,54	4,89	7,15	1,80	3,97	6,69	2,15	3,11
	15	8,11	1,23	6,58	7,88	1,54	5,13	7,53	1,81	4,17	7,14	2,19	3,25
	20	9,04	1,18	7,70	8,82	1,50	5,87	8,42	1,81	4,65	8,03	2,26	3,56
	-20	2,31	1,34	1,73	2,23	1,43	1,55	2,08	1,47	1,41	-	-	-
	-15	2,71	1,32	2,05	2,58	1,44	1,80	2,41	1,50	1,61	-	-	-
	-10	3,32	1,33	2,50	3,18	1,48	2,16	2,97	1,57	1,90	2,86	1,76	1,63
	-7	3,76	1,35	2,80	3,60	1,51	2,38	3,37	1,62	2,08	3,23	1,82	1,78
	-2	4,89	1,41	3,47	4,66	1,61	2,90	4,36	1,75	2,50	4,12	1,98	2,09

COOLING - MINIMUM LOAD							
Model i-290	T air outdoor [°C]	Tout [°C]					
		5			7		
		Cooling capacity [kW]	Power input [kW]	EER [W/W]	Cooling capacity [kW]	Power input [kW]	EER [W/W]
0106	20	3,04	0,48	6,34	4,39	0,44	9,98
	25	2,77	0,59	4,73	4,17	0,52	7,97
	30	2,59	0,67	3,84	3,86	0,65	5,94
	35	2,35	0,79	2,97	3,62	0,76	4,74
	40	2,19	0,90	2,45	3,39	0,85	3,98
	46	2,03	1,01	2,02	3,15	0,98	3,22
0109	20	4,28	0,64	6,71	5,74	0,56	10,3
	25	4,10	0,71	5,75	5,64	0,64	8,76
	30	3,82	0,80	4,78	5,44	0,73	7,43
	35	3,54	0,90	3,96	5,12	0,84	6,12
	40	3,17	1,01	3,15	4,70	0,96	4,88
	46	2,80	1,12	2,50	4,38	1,10	3,99
0112	20	5,39	0,92	5,83	7,21	0,87	8,29
	25	5,03	1,08	4,64	6,96	1,01	6,91
	30	4,61	1,22	3,79	6,58	1,24	5,33
	35	4,24	1,39	3,05	6,38	1,38	4,63
	40	3,71	1,62	2,29	5,83	1,61	3,62
	46	3,33	1,77	1,88	5,32	1,75	3,04
0115	20	6,10	0,99	6,17	8,97	0,85	10,6
	25	5,63	1,12	5,02	8,24	1,01	8,12
	30	5,15	1,29	3,99	7,66	1,22	6,27
	35	4,61	1,50	3,08	7,20	1,45	4,98
	40	4,22	1,71	2,47	6,56	1,71	3,85
	46	3,83	1,86	2,06	6,01	1,90	3,16
0118	20	6,27	1,00	6,28	8,59	0,90	9,51
	25	5,74	1,15	4,98	8,25	1,07	7,71
	30	5,40	1,34	4,03	7,92	1,26	6,30
	35	4,94	1,54	3,22	7,52	1,48	5,10
	40	4,58	1,75	2,61	6,87	1,74	3,96
	46	4,38	1,83	2,39	6,26	1,94	3,23

10. SEASONAL PERFORMANCE AT DIFFERENT TEMPERATURE LEVELS

The values of the seasonal performance coefficients SCOP, heating energy efficiency $\eta_{s,h}$ and design heat output P_{design} for the i-290 series units are shown. The data are calculated for three temperature levels according to UNI EN 14825: low (LT), medium (MT) and high (HT).

- LT: Heating in medium climate conditions, $T_{biv} = -7$ °C, low temperature (35 °C), variable output, fixed flow rate.
- MT: Heating in medium climate conditions, $T_{biv} = -7$ °C, medium temperature (55 °C), variable output, fixed flow rate.
- HT: Heating in medium climate conditions, $T_{biv} = -7$ °C, high temperature (65 °C), variable output, fixed flow rate.

Model i-290	P _{design} (LT)	SCOP (LT)	$\eta_{s,h}$ (LT)	P _{design} (MT)	SCOP (MT)	$\eta_{s,h}$ (MT)	P _{design} (HT)	SCOP (HT)	$\eta_{s,h}$ (HT)
	kW	W/W	%	kW	W/W	%	kW	W/W	%
0106	5,13	4,74	186	4,94	3,40	133	4,88	3,13	122
0109	9,00	5,19	205	8,88	3,93	154	9,11	3,51	137
0112	9,61	4,88	192	9,39	3,59	140	9,38	3,23	126
0115	14,6	4,85	191	13,5	3,79	149	13,6	3,40	133
0118	15,0	4,76	188	14,0	3,73	146	14,0	3,39	133

11. DATA FOR THE ENERGY CERTIFICATION OF BUILDINGS ACCORDING TO UNI/TS 11300-4 FOR HEAT PUMPS

The supplementary data of heat pumps for the calculation of the energy performance of buildings according to UNI/TS 11300 part 4 are given below.

The characteristics quantities that will be provided for each model are explained below, according to statement 30 of the standard.

		A T _{bival}	B	C	D
Reference temperature	-10°C	-7°C	2°C	7°C	12°C
PLR (T _{des} = -10°C)	100%	88%	54%	35%	15%
Power DC at full load		DC _A = DC _{bival}	DC _B	DC _C	DC _D
COP at partial load		COP _A	COP _B	COP _C	COP _D
COP at full load		COP'A	COP'B	COP'C	COP'D
CR	>1	1	(0,54 x P _{des}) / DC _B	(0,35 x P _{des}) / DC _C	(0,15 x P _{des}) / DC _D
Correction factor Fp	1	1	COP _B /COP'B	COP _C /COP'C	COP _D /COP'D
PLR	part load ratio - climatic load factor				
CR	heat pump load factor				
DC	full load power at indicated temperatures				
DC _{bival}	full load power at -7/35°C				
P _{design}	full load with temperate climate				
COP	COP with CR load at the same temperature conditions as COP'				
COP'	COP at full load under the same temperature conditions as COP				

Model i-290 0106

Operating limits

COLD source:		OUTDOOR AIR	
Operating temperature (cut-off)		min	-20°C
		max	20°C
HOT source:		WATER	
(cut-off)		min	22°C
Operating temperature (cut-off)		max	75°C

Performance data measured in partial load conditions, according to UNI/TS 11300-4

Operating conditions	A T _{bival}	B	C	D
Reference temperature	-7°C	2°C	7°C	12°C
PLR (T _{design} = -10°C)	88%	54%	35%	15%
Power DC at full load	4,50	5,87	6,24	6,39
COP at partial load	2,81	3,91	4,63	5,23
COP at full load	2,81	3,91	4,76	5,56
CR	1,00	1,00	0,88	0,33
Correction factor Fp	1,00	1,00	0,97	0,94

Model i-290 0109

Operating limits

COLD source:	OUTDOOR AIR	
Operating temperature (cut-off)	min	-20°C
	max	20°C
HOT source:	WATER	
Operating temperature (cut-off)	min	22°C
	max	75°C

Performance data measured in partial load conditions, according to UNI/TS 11300-4

Operating conditions	A T _{bival}	B	C	D
Reference temperature	-7°C	2°C	7°C	12°C
PLR (T _{design} = -10°C)	88%	54%	35%	15%
Power DC at full load	7,93	8,69	9,69	10,3
COP at partial load	2,98	4,44	5,41	5,67
COP at full load	2,98	3,85	4,72	5,60
CR	1,00	1,00	1,00	0,49
Correction factor F _p	1,00	1,15	1,15	1,01

Model i-290 0112

Operating limits

COLD source:	OUTDOOR AIR	
Operating temperature (cut-off)	min	-20°C
	max	20°C
HOT source:	WATER	
Operating temperature (cut-off)	min	22°C
	max	75°C

Performance data measured in partial load conditions, according to UNI/TS 11300-4

Operating conditions	A T _{bival}	B	C	D
Reference temperature	-7°C	2°C	7°C	12°C
PLR (T _{design} = -10°C)	88%	54%	35%	15%
Power DC at full load	8,52	11,6	12,6	13,6
COP at partial load	2,84	3,79	5,82	5,91
COP at full load	2,84	3,93	4,83	5,97
CR	1,00	1,00	0,97	0,37
Correction factor F _p	1,00	0,96	1,20	0,99

Model i-290 0115

Operating limits

COLD source:		OUTDOOR AIR	
Operating temperature (cut-off)		min	-20 °C
		max	20 °C
HOT source		WATER	
Operating temperature (cut-off)		min	22 °C
		max	75 °C

Performance data measured in partial load conditions, according to UNI/TS 11300-4

Operating conditions	A T _{bival}	B	C	D
Reference temperature	-7°C	2°C	7°C	12°C
PLR (T _{design} = -10°C)	88%	54%	35%	15%
Power DC at full load	12,9	15,9	16,3	17,0
COP at partial load	2,91	4,44	4,88	5,42
COP at full load	2,91	4,12	4,94	5,78
CR	1,00	1,00	1,00	0,44
Correction factor F _p	1,00	1,08	0,99	0,94

Model i-290 0118

Operating Limits

COLD source:		OUTDOOR AIR	
Operating temperature (cut-off)		min	-20°C
		max	20°C
HOT source:		WATER	
Operating temperature (cut-off)		min	22°C
		max	75°C

Performance data measured in partial load conditions, according to UNI/TS 11300-4

Operating conditions	A T _{bival}	B	C	D
Reference temperature	-7°C	2°C	7°C	12°C
PLR (T _{design} = -10°C)	88%	54%	35%	15%
Power DC at full load	12,6	17,9	18,7	19,6
COP at partial load	2,88	4,30	4,72	5,26
COP at full load	2,88	3,92	4,62	5,34
CR	1,00	1,00	1,00	0,43
Correction factor F _p	1,00	1,10	1,02	0,98

11.1 EER DATA TO CALCULATE THE ENERGY PERFORMANCE OF BUILDINGS, ACCORDING TO UNI/TS 11300-3

The EER coefficients under partial load conditions for i-290 reversible heat pumps are provided.

The conditions of reference under partial load specified by standard UNI/TS 11300-3 for air-water reversible chillers and heat pumps are shown below.

The EER are also provided for load factors lower than 25%.

Test	Load factor	Outdoor air dry bulb temperature	Chilled water temperature on fan coil input/output
1	100%	35	12/7
2	75%	30	(*)/7
3	50%	25	(*)/7
4	25%	20	(*)/7

(*) temperature set by the full load water flow rate

Model i-290 0106

i-290 0106			
Outdoor air dry bulb temperature [°C]	Load factor F%	EER	Cooling capacity [kW]
35	100%	2,79	5,43
30	75%	3,59	4,02
25	50%	4,38	2,67
20	25%	5,23	1,62

C	Load factor F%	EER @20°C xC
0,95	20%	4,96
0,94	15%	4,91
0,87	10%	4,55
0,71	5%	3,71
0,46	2%	2,40
0,29	1%	1,52

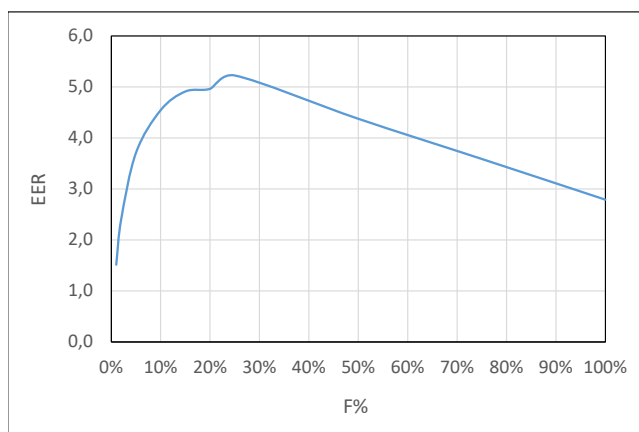

Model i-290 0109

i-290 0109			
Outdoor air dry bulb temperature [°C]	Load factor F%	EER	Cooling capacity [kW]
35	100%	3,09	8,57
30	75%	4,00	6,44
25	50%	5,25	4,29
20	25%	5,62	2,64

C	Load factor F%	EER @20°C xC
0,95	20%	5,34
0,94	15%	5,28
0,87	10%	4,89
0,71	5%	3,99
0,46	2%	2,58
0,29	1%	1,63

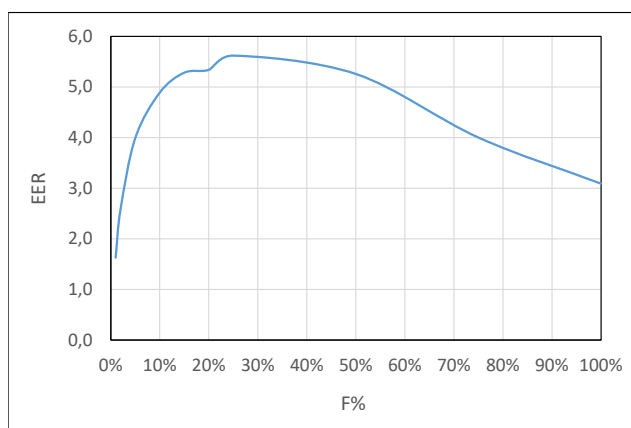

Model i-290 0112

i-290 0112			
Outdoor air dry bulb temperature [°C]	Load factor F%	EER	Cooling capacity [kW]
35	100%	2,85	10,67
30	75%	3,84	7,87
25	50%	4,87	5,21
20	25%	5,48	3,67

C	Load factor F%	EER @20°C xC
0,95	20%	5,20
0,94	15%	5,15
0,87	10%	4,77
0,71	5%	3,89
0,46	2%	2,52
0,29	1%	1,59

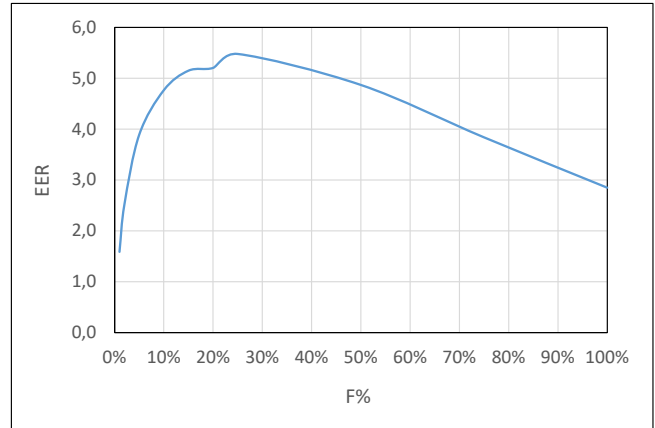

Model i-290 0115

i-290 0115			
Outdoor air dry bulb temperature [°C]	Load factor F%	EER	Cooling capacity [kW]
35	100%	3,35	12,41
30	75%	4,51	9,19
25	50%	5,50	6,10
20	25%	7,05	4,51

C	Load factor F%	EER @20°C xC
0,95	20%	6,69
0,94	15%	6,62
0,87	10%	6,13
0,71	5%	5,00
0,46	2%	3,24
0,29	1%	2,04

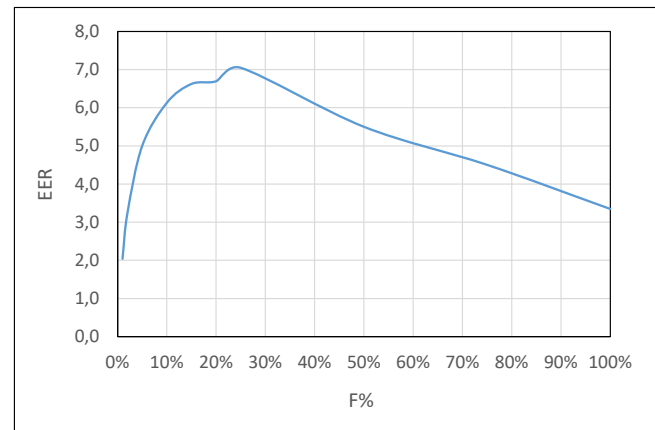

Model i-290 0118

i-290 0118			
Outdoor air dry bulb temperature [°C]	Load factor F%	EER	Cooling capacity [kW]
35	100%	3,16	13,75
30	75%	4,16	10,23
25	50%	5,31	6,79
20	25%	6,42	4,30

C	Load factor F%	EER @20°C xC
0,95	20%	6,10
0,94	15%	6,03
0,87	10%	5,58
0,71	5%	4,56
0,46	2%	2,95
0,29	1%	1,86

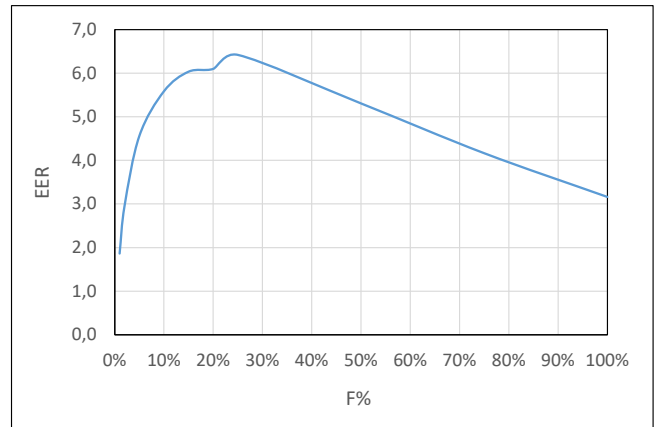

12. REFRIGERANT SAFETY DATA SHEET

Name:	R290
HAZARDS IDENTIFICATION	
Main hazards:	Highly flammable gas. Vapours are heavier than air and can cause asphyxiation due to reduced oxygen levels.
Specific hazards:	Contact with the liquid can cause frost burns.
FIRST AID MEASURES	
General information:	In high concentrations it can cause asphyxia. Symptoms may include loss of mobility and/or consciousness. In low concentrations it may have a narcotic effect.
Inhalation:	Move the victim to an uncontaminated area while wearing self-contained breathing apparatus. Use oxygen or artificial respiration if necessary. Keep the patient lying down and warm. Call a doctor.
Eye contact:	Carefully rinse with plenty of water for at least 15 minutes.
Skin contact:	Wash immediately with plenty of water for at least 15 minutes. Immediately remove contaminated clothing.
FIRE FIGHTING MEASURES	
Extinguishing media:	Water spray, dry powder.
Specific hazards:	Exposure to flames may cause the vessel to rupture or explode.
Specific methods:	Cool down the containers with a water spray from a safe position. Stop the product leakage if possible. Use water spray, if possible, to abate the fumes. Move the vessels away from the area of the fire if this can be done without posing any risks.
ACCIDENTAL RELEASE MEASURES	
Personal precautions:	Try to stop the leak. Evacuate personnel to safety areas. Eliminate the ignition sources. Ensure proper ventilation. Avoid entering sewers, basements, excavations and areas where accumulation can be dangerous. Use personal protective equipment. Remain upwind.
Environmental precautions:	Try to stop the leak.
Cleaning methods:	Ventilate the area.
HANDLING AND STORAGE	
Handling: Technical measures/precautions:	Ensure sufficient air exchange and/or suction in the working area. Do not smoke. Keep away from sources of ignition (including electrostatic charges). Use only appropriate equipment, suitable for the product.
Advice for safe use:	Do not inhale the gas.
Storage:	Close carefully and store in a cool, and well ventilated area. Storage containers should be checked periodically. Do not store with other oxidants in general or other combustible substances. Containers must not be stored in conditions that could lead to corrosion. All electrical equipment in the storage area are compliant with the risk of explosive atmospheres formation.
EXPOSURE CONTROLS/PERSONAL PROTECTION	
Control parameters:	OEL: data not available. DNEL: data not available. PNEC: data not available.
Respiratory protection:	Filter masks can be used if the ambient conditions and duration of use are known.
Eye protection:	Safety goggles.
Hand protection:	Work gloves.
Hygienic measures:	No smoking.
PHYSICAL AND CHEMICAL PROPERTIES	
Colour:	Colourless.
Odour:	Odourless.
Boiling point:	-42,1 °C at atm press
Flash point:	470°C
Relative gas density (air=1)	1,50
Relative liquid density (water=1)	0,58
Solubility in water:	75 mg/l.
STABILITY AND REACTIVITY	
Stability:	Stable under normal conditions.
Materials to avoid: Decomposition products hazardous:	Air, oxidising agents . Keep away from heat sources/sparks/open flames/heated surfaces. Under normal conditions of storage and use, dangerous decomposition products should not be generated.
TOXICOLOGICAL INFORMATION	
Acute toxicity: Local effects: Long term toxicity:	CL50/inhalation/4 hours/on rat = 20000 ppm. No known effect. No known effect.
ENVIRONMENTAL INFORMATION	
Global warming potential GWP (R744=1):	0,02
Ozone Depletion Potential ODP (R11=1):	0
Disposal consideration:	Refer to the supplier's gas recovery programme. Avoid direct discharge into the atmosphere. Do not discharge where accumulation can be dangerous. Ensure that the emissions limits required by local regulations or specified in authorizations are not exceeded.

ADVANTIX SpA
Via S. Giuseppe Lavoratore 24,
37040 Arcole (VR) Italy
Tel. (+39).045.76.36.585
E-mail: info@advantixspa.it
www.maxa.it